

PHILIPPINE BIDDING DOCUMENTS

Government of the
Republic of the Philippines

Procurement of INFRASTRUCTURE PROJECTS

**First Edition
May 2025**

Preface

These Philippine Bidding Documents (PBD) for the procurement of Infrastructure Projects (hereinafter referred to also as the “Works”) through [*Competitive Bidding, Limited Source Bidding, or Competitive Dialogue*¹] have been prepared by the Government of the Philippines (GoP) for use by all branches, agencies, departments, bureaus, offices, or instrumentalities of the Government, including government-owned and/or -controlled corporations (GOCC), government financial institutions (GFI), state universities and colleges (SUC), local government units (LGU), and autonomous regional government. The procedures and practices presented in this document have been developed through broad experience, and are for mandatory² use in projects that are financed in whole or in part by the GoP or any foreign government/foreign or international financing institution in accordance with the provisions of the Implementing Rules and Regulations (IRR) of Republic Act No. 12009 (RA No. 12009).

This PBD is intended as a model for admeasurements (unit prices or unit rates in a bill of quantities) types of contract, which are the most common in Works contracting.

The Bidding Documents shall clearly and adequately define, among others: (a) the objectives, scope, and expected outputs and/or results of the proposed contract; (b) the eligibility requirements of Bidders; (c) the expected contract duration; and (d) the obligations, duties, and/or functions of the winning bidder.

In order to simplify the preparation of the Bidding Documents for each procurement, the PBD groups the provisions that are intended to be used unchanged in Section II. Instructions to Bidders (ITB) and in Section IV. General Conditions of Contract (GCC). Data and provisions specific to each procurement and contract should be included in Section III. Bid Data Sheet (BDS); Section V. Special Conditions of Contract (SCC); Section VI. Specifications; Section VII. Drawings; and Section VIII. Bill of Quantities. The forms to be used are provided in Section IX. Philippine Bidding Documents Related Forms.

Prudence must be exercised to check the relevance of the provisions of the PBD against the requirements of the specific Works to be procured. In addition, each Section is prepared with notes intended only as information for the Procuring Entity or the person drafting the Bidding Documents. They shall not be included in the final documents, except for the notes introducing Section IX. Philippine Bidding Documents Related Forms, where the information is useful for the Bidder. The following general directions should be observed when using the documents:

- a) All the documents listed in the Table of Contents are normally required for the procurement of Infrastructure Projects. However, they should be adapted as necessary to the circumstances of the particular Project.
- b) Specific details, such as the “name of the Procuring Entity” and “address for proposal submission,” should be furnished in the BDS and SCC. The final documents should contain neither blank spaces nor options.

¹ For Second Stage of Competitive Dialogue under Section 29.4.2 of IRR of RA No. 12009.

² Unless the Treaty or International or Executive Agreement expressly provides use of foreign government/foreign or international financing institution procurement guidelines.

- c) This Preface and the footnotes, or notes in italics included in the Invitation to Bid, BDS, SCC, Specifications, Drawings, and Bill of Quantities are not part of the text of the final document, although they contain instructions that the Procuring Entity should strictly follow. The Bidding Documents should not contain footnotes except Section IX. Philippine Bidding Documents Related Forms since these provide important guidance to Bidders.
- d) The cover page should be modified as required to identify the Bidding Documents and date of issue.
- e) The Project title page should be modified as required to identify the Project title and number, name and address of the Procuring Entity.
- f) If modifications must be made to the bidding requirements, they can be presented in the BDS. Modifications for specific Project or Contract details should be provided in the SCC as amendments to the Conditions of Contract. For easy completion, whenever reference has to be made to specific clauses in the BDS or SCC, these terms shall be printed in bold type face on Section II. Instructions to Bidders, and Section IV. General Conditions of Contract, respectively. To facilitate easy reference and completion, clauses from the BDS and SCC shall appear in bold type face in Sections II and IV, respectively.



Republic of the Philippines
TECHNICAL EDUCATION AND SKILLS DEVELOPMENT AUTHORITY
ISO 9001: 2015 Certified



Procurement of INFRASTRUCTURE PROJECTS

*Creation of TESDA-ISAT Diploma Center
(Rebidding)*

TESDAR02-2026-002

TABLE OF CONTENTS

Glossary of Acronyms, Terms, and Abbreviations	6
Definition of Terms	8
Section I. Invitation to Bid.....	11
Section II. Instructions to Bidders	16
A. General	19
B. Contents of Bidding Documents	26
C. Preparation of Bids	27
D. Submission and Opening of Bids	35
E. Evaluation and Comparison of Bids	37
F. Award of Contract	42
Section III. Bid Data Sheet	45
Section IV. General Conditions of Contract	54
Section V. Special Conditions of Contract	84
Section VI. Specifications	89
Section VII. Drawings	91
Section VIII. Bill of Quantities.....	92
Section IX. Philippine Bidding Documents Related Forms	94

Glossary of Acronyms, Terms, and Abbreviations

ABC – Approved Budget for the Contract.

ADR – Alternative Dispute Resolution.

ARCC – Allowable Range of Contract Cost.

BAC – Bids and Awards Committee.

BIR – Bureau of Internal Revenue.

BSP – Bangko Sentral ng Pilipinas.

CDA – Cooperative Development Authority.

COS – Contract of Service.

CPI – Consumer Price Index.

DOLE – Department of Labor and Employment.

DTI – Department of Trade and Industry.

GCC - General Conditions of Contract.

GFI – Government Financial Institution.

GOCC – Government-Owned and/or –Controlled Corporation.

GoP – Government of the Philippines.

GPPB – Government Procurement Policy Board.

HoPE – Head of Procuring Entity.

JO – Job Order.

IRR – Implementing Rules and Regulations.

ITB – Instructions to Bidders.

LCB- Lowest Calculated Bid.

LCRB – Lowest Calculated Responsive Bid.

LGUs – Local Government Units.

LoC – Line of Credit

MAB – Most Advantageous Bid.

MARB – Most Advantageous Responsive Bid.

MEARB – Most Economically Advantageous Responsive Bid.

MYCA – Multi-Year Contracting Authority.

NFCC – Net Financial Contracting Capacity.

NGA – National Government Agency.

PCAB – Philippine Contractors Accreditation Board.

PhilGEPS - Philippine Government Electronic Procurement System.

PSA – Philippine Statistics Authority.

RA No. – Republic Act Number.

SARB – Single Advantageous and Responsive Bid.

SCC - Special Conditions of Contract.

SCRB – Single Calculated and Responsive Bid.

SEARB – Single Economically Advantageous Responsive Bid.

SEC – Securities and Exchange Commission.

SLCC – Single Largest Completed Contract.

SRRB – Single Rated and Responsive Bid.

UN – United Nations.

Definition of Terms

Bid – a signed offer, proposal, or quotation submitted by a supplier, manufacturer, distributor, contractor, consultant, or service provider in response to the requirements of the Procuring Entity as stated in the Bidding Documents. (IRR of RA No. 12009, Section 5[c]).

Bidder – a supplier, manufacturer, distributor, contractor, consultant, and service provider, whether public or private, who submits a Bid in response to the requirements of the Procuring Entity as stated in the Bidding Documents. (IRR of RA No. 12009, Section 5[d]).

Bidding Documents – the documents issued by the Procuring Entity as the basis for Bids, furnishing all information necessary to prospective bidder to prepare a Bid for the Goods, Infrastructure Projects, and Consulting Services required by the Procuring Entity. (IRR of RA No. 12009, Section 5[e])

Bill of Quantities – a list of the specific items of the Work and their corresponding unit prices, lump sums, and/or provisional sums.

Consulting Services – services for Infrastructure Projects and other types of projects or activities of the government requiring adequate external technical and professional expertise that are beyond the capability or capacity of the government to undertake such as, but not limited to: (i) advisory and review services; (ii) pre-investment or feasibility studies; (iii) design; (iv) construction supervision; (v) management and related services; and (vi) other technical services or special studies. (IRR of RA No. 12009, Section 5[i]).

Contract – the agreement entered into between the Procuring Entity and the Contractor to execute, complete, and maintain the Works and as recorded in the Contract Form signed by the parties, including all attachments and appendices thereto and all documents incorporated by reference therein.

Contract Price – the price stated in the Notice of Award and thereafter to be paid by the Procuring Entity to the Contractor for the execution of the Works in accordance with this Contract.

Contract Time Extension (CTE) – the allowable period for the Contractor to complete the Works in addition to the original Completion Date stated in this Contract.

Contractor – a natural or juridical entity whose proposal was accepted by the Procuring Entity and to whom the Contract to execute the Work was awarded. Contractor as used in these Bidding Documents may likewise refer to a supplier, distributor, manufacturer, or consultant.

Days – refers to calendar days; months to calendar months.

Dayworks – varied work inputs subject to payment on a time basis for the Contractor's employees and Equipment, in addition to payments for associated Materials and Plant.

Defect – any part of the Works not completed in accordance with the Contract.

Defects Liability Certificate – the certificate issued by the Procuring Entity upon correction of defects by the Contractor.

Defects Liability Period – the one (1) year period between contract completion and final acceptance within which the Contractor assumes the responsibility to undertake the repair of any damage to the Works at its own expense.

Drawings – graphical presentations of the Works. They include all supplementary details, shop drawings, calculations, and other information provided or approved for the execution of this Contract.

Effective Date of the Contract – the date indicated in the contract. However, the Contractor shall commence performance of its obligations only upon receipt of the Notice to Proceed.

Foreign-funded Procurement or Foreign-Assisted Project – refers to the acquisition of Goods, Consulting Services, and the contracting for Infrastructure Projects by the Government of the Philippines which are wholly or partly funded by foreign loans or grants pursuant to a Treaty or International or Executive Agreement.

Funding Source – Organization named in the SCC.

Goods – refer to (i) all items, supplies, and materials, whether in the nature of equipment, furniture, stationery, materials for construction, or personal property of any kind, needed in the transaction of public businesses or in the pursuit of any government undertaking, project or activity; or (ii) general support services which pertain to all types of services except Consulting Services and Infrastructure Projects, such as the repair and maintenance of equipment and furniture, as well as trucking, hauling, janitorial, security, and related or analogous services. Personnel Services or individual COS or JO engagements do not fall under this definition; (IRR of RA No. 12009, Section 5[n]).

Infrastructure Projects – include the construction, improvement, rehabilitation, demolition, repair, restoration, or maintenance of roads and bridges, railways, airports, seaports, communication facilities, civil works components of information technology projects, irrigation, flood control and drainage, water supply, sanitation, sewerage and solid waste management systems, shore protection, energy/power and electrification facilities, national buildings, school buildings, hospital buildings, and other related construction projects of the government. Also referred to as “civil works” or “works;” (IRR of RA No. 12009, Section 5[r]).

Lot – refers to one or more infrastructure projects that are grouped or bundled together based on factors, such as scope, location, or other relevant parameters, as determined by the End-User or Implementing Unit of the Procuring Entity. Each lot is distinct within the project and may be awarded as a separate contract.

MARB – refers to the award criteria in the procurement of Infrastructure where the considerations for the award of contract are the eligibility of the bidder, the responsiveness of its bid to the technical requirements, and the most advantageous bid in reference to the highest rated offer based on the quality component of the bid.

Materials – refer to all supplies, including consumables, used by the Contractor for incorporation in the Works.

MEARB – refers to the award criteria in the procurement of Infrastructure where the considerations for the award of contract are the eligibility of the bidder, the responsiveness of its bid to the technical requirements, and the determination of the most economically advantageous bid in reference to the quality-price ratio allocated to the technical and financial components of the bid.

Notice to Proceed – refers to a written notice issued by the Procuring Entity to the Contractor requiring the latter to begin the commencement of the work not later than a specified or determinable date.

Online submission – pertains to the submission of the bid for Infrastructure Projects and the bid envelopes containing the technical and financial components of the bid through electronic means or through the electronic bidding facility of the PhilGEPS, once available.

Permanent Works – refer to all permanent structures and all other project features and facilities required to be constructed and completed in accordance with this Contract which shall be delivered to the Procuring Entity, and which shall remain at the Site after the removal of all Temporary Works.

Plant – refers to the machinery, apparatus, and the like intended to form an integral part of the Permanent Works.

Procuring Entity - the organization acquiring the Infrastructure Project, as named in the SCC.

Project – refers to a specific or identified procurement covering Goods, Infrastructure Projects or Consulting Services. A Procurement Project shall be described, detailed, and scheduled in the Project Procurement Management Plan prepared by the agency which shall be consolidated in the Procuring Entity's Annual Procurement Plan.

Program of Work – refers to the big-picture plan and comprehensive schedule that details construction-related tasks to ensure the timely and efficient delivery of the project.

Site Investigation Reports – refers to those that were included in the Bidding Documents and are factual and interpretative reports about the surface and subsurface conditions at the Site.

Slippage – refers to a delay in work execution occurring when actual accomplishment falls below the target as measured by the difference between the scheduled and actual accomplishment of the Work by the Contractor as established from the work schedule. This is actually described as a percentage of the whole Works.

Simple Infrastructure Projects – refers to construction, improvement, rehabilitation, demolition, repair, restoration, or maintenance of structures, technical facilities and systems with an Approved Budget for the Contract (ABC) not exceeding Ten Million Pesos (PhP 10,000,000.00) built at the community level for the sustenance of lives and livelihoods of the population living in a community and built according to the needs and aspirations of the community population.

Verified Report – the report submitted by the Implementing Unit to the HoPE setting forth its findings as to the existence of grounds or causes for termination and explicitly stating its recommendation for the issuance of a Notice to Terminate.

Section I. Invitation to Bid

Notes on the Invitation to Bid

The Invitation to Bid provides information that enables potential Bidders to decide whether to participate in the procurement at hand. The Invitation to Bid shall be:

- a) In line with the principles of transparency and competitiveness and to ensure the widest possible dissemination thereof, all invitations to bid shall be published continuously by the Procuring Entity, for seven (7) calendar days on the Philippine Government Electronic Procurement System (PhilGEPS) website, in any conspicuous place reserved for this purpose in the premises of the Procuring Entity, and on the website or social media platforms of the Procuring Entity, if available, or such other channels as may be authorized by the Government Procurement Policy Board (GPPB), and the website prescribed by the foreign government/foreign or international financing institution, if applicable; and
- b) For justifiable reasons, Procuring Entities that cannot publish procurement opportunities on its website, social media platform, or such other channels authorized by the GPPB shall publish its invitation to bid, at least once, in a newspaper of general nationwide circulation.

Apart from the essential items listed in the Bidding Documents, the Invitation to Bid should also indicate the following:

- a) The availability of the Bidding Documents, which shall commence from the time the Invitation to Bid is first published until the deadline for submission and continue until the deadline for submission and receipt of bids;
- b) The place where the Bidding Documents may be acquired or the website where it may be downloaded;
- c) The deadline for the submission and receipt of bids;
- d) The procurement strategy/ies; and
- e) The bid award criterion/criteria. (e.g., the application of a margin of preference in bid evaluation)

The Invitation to Bid should be incorporated into the Bidding Documents. The information contained in the Invitation to Bid must conform to the Bidding Documents, particularly to the relevant information in the BDS.



Invitation to Bid for *Creation of TESDA-ISAT Diploma Center (Rebidding)*

- 1) The *Technical Education and Skills Development Authority - Isabela School of Arts and Trades (TESDA-ISAT)*, through the *General Appropriations Act (GAA) 2026* intends to apply the sum of **Forty Million Ten Thousand Pesos Only (Php 40,010,000.00)** being the Approved Budget for the Contract (ABC) to payments under the contract for **Creation of TESDA-ISAT Diploma Center (Rebidding)**. Bids received in excess of the ABC shall be automatically rejected at bid opening.
- 2) The *Technical Education and Skills Development Authority - Isabela School of Arts and Trades (TESDA-ISAT)* now invites bids for **Construction of One Unit Three-Storey Diploma Bulding Located at TESDA-ISAT, Calamagui 2nd, City of Ilagan, Isabela**. Completion of the Works is required **270 Calendar Days**. Bidders should have completed, within **Five (5) Years** from the date of submission and receipt of bids, a contract similar to the Project. The description of an eligible bidder is contained in the Bidding Documents, particularly, in Section II. Instructions to Bidders (ITB).
- 3) Bidding will be conducted through competitive bidding procedures using a non-discretionary “pass/fail” criterion as specified in the IRR, otherwise known as the “New Government Procurement Act (NGPA)”.

Bidding is restricted to Filipino citizens/sole proprietorships, cooperatives, and partnerships or organizations with at least sixty percent (60%) interest or outstanding capital stock belonging to citizens of the Philippines.

- 4) Interested bidders may obtain further information from *Technical Education and Skills Development Authority – Region II* and inspect the Bidding Documents at the address given below from **8:00am to 5:00pm**.
- 5) A complete set of Bidding Documents may be acquired by interested bidders on **11 April 2026** from the address below **and upon payment of the applicable fee for the Bidding Documents, pursuant to the latest Guidelines issued by the GPPB, in the amount of Twenty-Five Thousand Pesos Only (Php 25,000.00)**.

It may also be downloaded free of charge from the website of the Philippine Government Electronic Procurement System (PhilGEPS) and the website of the Procuring Entity, provided that bidders shall pay the applicable fee for the Bidding Documents not later than the submission of their bids.

- 6) The *Technical Education And Skills Development Authority - TESDA Regional Office II* will hold a Pre-Bid Conference on **20 April 2026 @ 09:00am** at **Gladys F. Rosales Hall, TESDA Regional Office II, Carig Norte, Tuguegarao City, Cagayan** and/or through video conferencing via **Zoom platform through this link: <https://us02web.zoom.us/j/86947447494?pwd=BbkjZeKiDxg3BCUDHcFWgNR8zpJg5L.1>**, **Zoom Meeting ID: 869 4744 7494 Passcode: tesdar02**, which shall be open to prospective bidders.

All prospective bidders are highly encouraged to attend the Pre-Bid Conference via face-to-face to preclude omission/commission of errors on the submitted Bidding Documents specifically on the Technical Component Envelope, Financial Component Envelope and the Additional Requirements for the MEAB Quality Checklist.

- 7) Bids must be duly received by the Bids and Awards Committee (BAC) Secretariat through **Manual Submission at the address indicated below** on or before **04 May 2026 @ 07:45am**. Late bids shall not be accepted.
- 8) All Bids must be accompanied by a Bid Security in any of the acceptable forms and in the amount stated in **ITB** Clause 16.
- 9) Bid opening shall be on **04 May 2026 @ 08:00am** at **Gladys F. Rosales Hall, TESDA Regional Office II, Carig Norte, Tuguegarao City, Cagayan** and/or via **Zoom platform through this link: <https://us02web.zoom.us/j/81228657098?pwd=QEoAoW1w7AF4bKJreDIr9dZha1RS7.1>, Zoom Meeting ID: 812 2865 7098** Passcode: **tesdar02**. **The Bid opening shall be livestream using the Official Facebook page of TESDA Region II (<https://facebook.com/TESDARegionII>)**. Bids will be opened in the presence of the Bidders' representatives who choose to attend the activity.
- 10) **Site inspection may be conducted by the prospective bidder or authorized representative at TESDA-ISAT, Calamagui 2nd, City of Ilagan, Isabela. For scheduling of site inspection, you may contact Ms. Ma Elena A. Narciso, Acting Vocational School Superintendent thru her contact number 09555813662 or Mr. Rodelio B. Tinaza, Associate Professor III thru his contact number 09151329573.**

The bidding fee of the Bidding Documents may be paid directly thru the following bank details:

<i>Bank Name/Branch</i>	<i>Landbank of The Philippines Tuguegarao Capitol Branch</i>
<i>Bank Account Name</i>	<i>TESDA R02 TRUST FUND</i>
<i>Bank Account Number</i>	<i>3702 1017 85</i>

Official Receipts shall be issued upon presentation or email of the validated deposit slip.

Note: Utilization of the provided Forms in Section IX. Philippine Bidding Documents Related Forms shall be mandatory and any deviation from the provided documents will be sufficient ground for disqualification.

Additional Instructions for the Bid Documents to be submitted as follows:

- a) The Bidders are to provide three copies of each submitted documents (Technical Component Envelope and Financial Component Envelope) to be named as Original Copy, Copy 1 and Copy 2.
- b) The MEAB Quality Proposal Documents are to be included in the Technical Component Envelope.
- c) Based on the Checklist of Bid Documents, prepare a tabbing system corresponding to the titles of the required documents for ease of reference and verification. For example, if the required document is "PhilGEPS Certificate of Registration (Platinum Membership) in

accordance with Section 20 of the IRR (all pages),” the appropriate tab label should be “PhilGEPS Registration”.

11) The **TESDA Regional Office II** reserves the right to reject any and all bids, declare a failure of bidding, or not award the contract at any time prior to contract award in accordance with Section 70 of R.A. No. 12009, without thereby incurring any liability to the affected bidder or bidders.

12) For further information, please refer to:

Ms. Imelda V. Gervacio
RBAC Secretariat Office
Administrative Building, TESDA Regional Office II,
Carig Norte, Tuguegarao City, Cagayan
Contact Number: 09173117263
Email: region2.supplysectiontesda@tesda.gov.ph
Website: region2.tesda.gov.ph

13) You may visit the following websites:

For downloading of Bidding Documents:

Operating Units	(Official Websites)
RO	https://region2.tesda.gov.ph/
PO Batanes	https://sites.google.com/tesda.gov.ph/tesda-batanes/home
PO Cagayan	https://sites.google.com/tesda.gov.ph/tesdacagayanprovincialoffice/home
PO Isabela	https://sites.google.com/site/tesdaisabela/
PO Nueva Vizcaya	https://www.tesdanv.com/
PO Quirino	https://sites.google.com/tesda.gov.ph/tesdaquirino/home
RTC Tuguegarao	https://sites.google.com/tesda.gov.ph/rtc02/
API	https://tesda-api.net/
LIT	https://sites.google.com/tesda.gov.ph/lasam-institute-of-technology/home
ISAT	https://www.tesdaisat.com.ph/
SICAT	https://sites.google.com/view/tesdasicat

NVPI	https://sites.google.com/tesda.gov.ph/official-website-of-nvpi/
------	---

11 April 2026

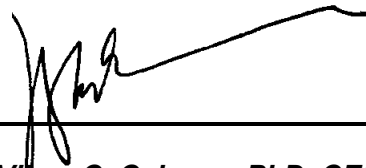

*PD Vilma C. Cabrera, PhD, CESO VI
RBAC Chairperson*

Section II. Instructions to Bidders

Notes on the Instructions to Bidders

This Section of the Bidding Documents provides the information necessary for Bidders to prepare responsive bids, in accordance with the requirements of the Procuring Entity. It also provides information on the bid submission, eligibility check, opening and evaluation of bids, post-qualification and award of contract.

This Section contains provisions that shall not be changed or modified. Any amendment shall be reflected in Section III. Bid Data Sheet which consists of provisions that supplement, amend, or specify in detail information or requirements included in this Section and which are specific to each procurement.

Matters governing performance of the Contractor, payments under the contract, or those affecting the risks, rights, and obligations of the parties under the contract are not normally included in this Section, but rather under Section IV. General Conditions of Contract (GCC), and/or Section V. Special Conditions of Contract (SCC). If duplication of a subject is inevitable in other sections of the document prepared by the Procuring Entity, prudence must be exercised to avoid contradictions between clauses dealing with the same matter.

TABLE OF CONTENTS

A. GENERAL	19
1. Scope of Bid.....	19
2. Source of Funds.....	19
3. Corrupt, Fraudulent, Collusive, Coercive, and Obstructive Practices.....	19
4. Conflict of Interest.....	20
5. Eligible Bidders.....	22
6. Bidder's Responsibilities.....	23
7. Origin of Goods and Services.....	26
8. Subcontracts.....	26
B. CONTENTS OF BIDDING DOCUMENTS	26
9. Pre-Bid Conference.....	26
10. Clarification and Amendment of Bidding Documents.....	27
C. PREPARATION OF BIDS	27
11. Language of Bids.....	27
12. Documents Comprising the Bid: Technical and Financial Components.....	28
13. Bid Prices.....	29
14. Bid Currencies.....	30
15. Bid Validity.....	30
16. Bid Security.....	30
17. Format and Signing of Bids.....	34
18. Sealing and Marking of Bids.....	34
D. SUBMISSION AND OPENING OF BIDS	35
19. Deadline for Submission of Bids.....	35
20. Late Bids.....	35
21. Modification and Withdrawal of Bids.....	35
22. Opening and Preliminary Examination of Bids.....	36
E. EVALUATION AND COMPARISON OF BIDS	37
23. Process to be Confidential.....	37
24. Clarification of Bids.....	37
25. Detailed Evaluation and Comparison of Bids.....	37
26. Post-Qualification.....	40
27. Reservation Clause.....	41

F. AWARD OF CONTRACT	42
28. Contract Award	42
29. Signing of the Contract	43
30. Performance Security	43
31. Notice to Proceed.....	44
32. Protest Mechanism	44

A. General

1) Scope of Bid

- 1.1 The Procuring Entity named in the **BDS**, invites Bids for the **Creation of TESDA-ISAT Diploma Center Rebidding** with Project Identification Number **TESDAR02-2026-002**.

The Procurement Project (referred to herein as "Project") is for the construction of Works, as described in Section VI (Specifications).

- 1.2 The winning Bidder will be expected to complete the Works by the intended completion date specified in **SCC** Clause 1.1.

2) Source of Funds

The Procuring Entity has a budget or received funds from the Funding Source named in the **BDS**, and in the amount indicated in the **BDS**. It intends to apply part of the funds received for this Project to cover eligible payments under the contract.

3) Corrupt, Fraudulent, Collusive, Coercive, and Obstructive Practices

- 3.1 Unless otherwise specified in the **BDS**, the Procuring Entity, as well as Bidders and Contractors, shall observe the highest standard of ethics during the procurement and execution of the contract. In pursuance of this policy, the Procuring Entity:

- a) defines, for purposes of this provision, the following terms under existing laws, rules, and regulations:
 - i) "corrupt practice" means an act by which officials in the public or private sectors improperly and unlawfully enrich themselves, others, or induce others to do so, by misusing the position in which they are placed, and includes the offering, giving, receiving, or soliciting of anything of value to influence the action of any such official in the procurement process or in contract execution; entering, on behalf of the government, into any contract or transaction manifestly and grossly disadvantageous to the same, whether or not the public officer profited or will profit thereby, and similar acts as provided in RA No. 3019.
 - ii) "fraudulent practice" means a misrepresentation of facts for purposes of influencing a procurement process or the execution of a contract to the detriment of the Procuring Entity, which includes collusive practices among Bidders (prior to or after bid submission) designed to establish bid prices at artificial, non-competitive levels and to deprive the Procuring Entity of the benefits of free and open competition.
 - iii) "collusive practices" means a scheme or arrangement between two or more Bidders, with or without the knowledge of the Procuring Entity, designed to establish bid prices at artificial, non-competitive levels.

- iv) “coercive practices” means harming or threatening to harm, directly or indirectly, persons, or their property to influence their participation in a procurement process, or affect the execution of a contract;
- v) “obstructive practice” is
 - a) deliberately destroying, falsifying, altering or concealing of evidence material to an administrative proceedings or investigation or making false statements to investigators in order to materially impede an administrative proceedings or investigation of the Procuring Entity or any foreign government/foreign or international financing institution relative to allegations of a corrupt, fraudulent, coercive or collusive practice; and/or threatening, harassing or intimidating any party to prevent the latter from disclosing its knowledge of matters relevant to the administrative proceedings or from pursuing such proceedings or investigation; or
 - b) acts intended to materially impede the exercise of the inspection and audit rights of the Procuring Entity or any foreign government/foreign or international financing institution herein.
- b) Undertakes to reject a proposal for award upon *prima facie* determination that the Bidder recommended for award has engaged in any of the prohibited practices mentioned in this Clause for purposes of competing for the contract.

3.2 Further, the Procuring Entity will seek to impose the maximum civil, administrative, and/or criminal penalties available under the applicable laws on individuals and organizations deemed to be involved in any of the practices mentioned in **ITB** Clause 4.

3.3 Furthermore, the Funding Source and the Procuring Entity reserve the right to inspect and audit records and accounts of a Bidder or Contractor in the bidding for and performance of a contract themselves or through independent auditors as reflected in the **GCC** Clause 36.

4) **Conflict of Interest**

4.1 All Bidders found to have conflicting interests shall be disqualified to participate in the procurement at hand, without prejudice to the imposition of appropriate administrative, civil, and criminal sanctions. A Bidder may be considered to have conflicting interests with another Bidder in any of the events described in paragraphs (a) through (c) and a general conflict of interest in any of the circumstances set out in paragraphs (d) through (f) below:

- a) A Bidder has controlling shareholders or beneficial owners in common with another Bidder;
- b) A Bidder receives or has received any direct or indirect subsidy from any other Bidder;

- c) A bidder has the same legally authorized representative as that of another Bidder for purposes of this Bid;
 - d) A bidder has a relationship, directly or through third parties, that puts them in a position to have access to information about or influence on the bid of another Bidder or influence the decisions of the Procuring Entity regarding this bidding process. This may include a firm or an organization that lends, or temporarily seconds, its personnel to firms or organizations that are engaged in consulting services for the preparation related to procurement for or implementation of the project if the personnel would be involved in any capacity on the same project;
 - e) A bidder who participated as a consultant in the preparation of the design or technical specifications of the goods and related services that are the subject of the bid; or
 - f) A bidder who lends, or temporarily seconds, its personnel to firms or organizations which are engaged in consulting services for the preparation related to procurement for or implementation of the project, if the personnel would be involved in any capacity on the same project.
- 4.2 All Bidding Documents shall be accompanied by an Omnibus Sworn Statement of the Bidder that it is not related, by consanguinity or affinity up to the third civil degree, to the HoPE, Procurement Agent (if engaged), the head of the Project Management Office (PMO), the End-User or Implementing Unit or any members of the Bids and Awards Committee (BAC), Technical Working Group (TWG), and BAC Secretariat.³
- 4.3 The Bidder shall also disclose the ultimate beneficial ownership of the entity it represents. Failure to comply shall be a ground for the automatic disqualification of the bid in consonance with Section 59 of the IRR. For this reason, relationship to the aforementioned persons within the third civil degree of consanguinity or affinity shall automatically disqualify the Bidder from participating in the procurement of contracts of the Procuring Entity notwithstanding the act of such persons inhibiting themselves from the procurement process. This Clause shall apply to the following persons and affiliates:
- a) In the case of individuals or sole proprietorships, to the Bidders and their spouses;
 - b) In the case of partnerships, to the partnership itself and its partners;
 - c) In the case of cooperatives, to the cooperative itself and members of the board of directors, general manager or chief executive officer;
 - d) In the case of a partnership, joint venture, or consortium, to the entity itself, its members or partners, as well as any person or entity that is a member of a blacklisted partnership, joint venture, or consortium; and

³ Section 81.1 of the IRR.

- e) In the case of corporations, a single stockholder, together with their relatives up to the third civil degree of consanguinity or affinity, and their assignees, holding at least twenty percent (20%) of the shares therein, its chairperson and president, shall be blacklisted after they have been determined to hold the same controlling interest in a previously blacklisted corporation or in two corporations that have been blacklisted; the corporations of which they are part shall also be blacklisted.

5) Eligible Bidders

- 5.1 Only Bids found to be legally, technically, and financially eligible will be evaluated. For procurement of Infrastructure Projects, the following persons shall be eligible to participate in this bidding:
 - a) Duly licensed Filipino citizens or sole proprietorships;
 - b) Partnerships duly organized under the laws of the Philippines and of which at least sixty percent (60%) of the interest belongs to citizens of the Philippines;
 - c) Corporations duly organized under the laws of the Philippines, and of which at least sixty percent (60%) of the outstanding capital stock belongs to citizens of the Philippines;
 - d) Cooperatives duly organized under the laws of the Philippines; and
 - e) Persons or entities forming themselves into a Joint Venture (JV), i.e., a group of two (2) or more persons or entities that intend to be jointly and severally responsible or liable for a particular contract; Provided, however, that in accordance with relevant laws, rules, and regulations, Filipino ownership or interest of the joint venture concerned shall be at least sixty percent (60%); Provided, further, that joint ventures in which Filipino ownership or interest is less than sixty percent (60%) may be eligible where the structures to be built require the application of techniques or technologies which are not adequately possessed by a person or entity meeting the sixty percent (60%) Filipino ownership requirement; Provided, furthermore, that in the latter case, Filipino ownership or interest shall not be less than twenty-five percent (25%). For this purpose, Filipino ownership or interest shall be based on the contributions of each of the member of the joint venture as specified in their Joint Venture Agreement (JVA); Provided, finally, that the primary purpose of each member of the joint venture must be similar or related to the requirement of the project to be bid out.
- 5.2 The Procuring Entity may also invite foreign bidders when provided for under any Treaty or International or Executive Agreement as specified in the **BDS**.
- 5.3 In accordance with RA No. 4566 or the “Contractors' License Law” as amended by RA No. 11711 or “An Act Further Amending Republic Act No. 4566”, the persons or entities enumerated in Section 52 of the IRR may participate in the procurement of Infrastructure Projects if it has been issued a license by the Philippine Contractors Accreditation Board (PCAB) to engage or act as a contractor.

- 5.4 The Bidder must have completed an SLCC that is similar to the procurement project to be bid, and whose value must be equivalent to at least fifty percent (50%) of the ABC, adjusted to current prices using the Philippine Statistics Authority (PSA) consumer price indices; Provided, that any change to the fifty percent (50%) requirement may be allowed, subject to the recommendation of the Procuring Entity, which shall be submitted to the GPPB for consideration; Provided, further, that contractors under Small A and Small B categories without similar experience on the procurement project to be bid may be allowed to bid if the cost of such contract is not more than the Allowable Range of Contract Cost of their registration based on the guidelines as prescribed by the PCAB.

For foreign-funded procurement, the GoP and the foreign government, or foreign or international financing institution may agree on another track record requirement, as specified in the **BDS**.

Moreover, a contract shall be considered similar to the procurement project if it has the same major categories of work. The Procuring Entity may clarify in the Bidding Documents what is regarded as major categories of work, guided by the principle of proportionality and Fit-for-Purpose approach.

- 5.5 The SLCC shall be supported by an Owner's Certificate of Final Acceptance issued by the project owner other than the Contractor, or a final rating of at least Satisfactory in the Constructors Performance Evaluation System (CPES), or a similar performance and monitoring system. In the case of contracts with the private sector, an equivalent document shall be submitted.
- 5.6 The computation of a bidder's NFCC must be at least equal to the ABC to be bid, calculated as follows:

NFCC = [(Current assets minus current liabilities) (15)] minus the value of all outstanding or uncompleted portions of the projects under ongoing contracts, including awarded contracts yet to be started, coinciding with the procurement project to be bid; Provided, That a different formula may be adopted subject to the recommendation of the Procuring Entity, which shall be submitted to the GPPB for consideration.

The value of the domestic bidder's current assets and current liabilities shall be based on the latest AFS submitted to the BIR.

For purposes of computing the foreign bidders' NFCC, the value of the current assets and current liabilities shall be based on their latest AFS prepared in accordance with international financial reporting standards.

6) Bidder's Responsibilities

- 6.1 The Bidder or its duly authorized representative shall submit a sworn statement in the form prescribed in Section IX. Philippine Bidding Documents Related Forms as required in **ITB** Clause 12.1(h)(iv).
- 6.2 Before submitting their bids, the Bidders are deemed to be knowledgeable of all existing laws, decrees, ordinances, acts and regulations of the Philippines which may affect this Project in any way.
- 6.3 The Bidder undertook the following responsibilities:

- a) Took steps to carefully examine and ensure full understanding and comprehension of the Bidding Document, its requirements, clauses, and provisions;
- b) Acknowledged all conditions, local or otherwise, affecting the implementation of the contract;
- c) Made an estimate of the facilities available and needed for the contract to be bid, if any;
- d) Complied with its responsibility to inquire or secure Supplemental Bid Bulletin(s);
- e) Ensured that it is not “blacklisted” or barred from bidding by the Government of the Philippines (GoP) or any of its agencies, offices, corporations, or LGUs, including foreign government, or foreign/international financing institutions whose blacklisting rules have been recognized by the GPPB; by itself or by reason of its relation, membership, association, affiliation, or controlling interest with another blacklisted person or entity;
- f) Ensured that each of the documents submitted in satisfaction of the bidding requirements is an authentic copy of the original, complete, and that all statements and information provided therein are true and correct;
- g) Authorized the HoPE or its duly authorized representative/s to verify all the documents submitted;
- h) Ensured that the signatory is the duly authorized representative of the Bidder, and granted full power and authority to do, execute and perform any and all acts necessary to participate, submit the bid, to sign, and execute the ensuing contract, accompanied by the duly notarized Special Power of Attorney, Board or Partnership Resolution, or Secretary’s Certificate, whichever is applicable;
- i) Complied with the disclosure provision under Section 81 and 82 of RA No. 12009 and its IRR in relation to other provisions of RA No. 3019;
- j) Complied with existing labor laws and standards. Moreover, the Bidder undertakes to:
 - i) Ensure the entitlement of workers to wages, hours of work, safety and health and other prevailing conditions of work as established by national laws, rules and regulations; or Collective Bargaining Agreement (CBA) or arbitration award, if and when applicable.

In case there is a finding by the Procuring Entity or the Department of Labor and Employment (DOLE) of underpayment or non-payment of workers’ wages and wage-related benefits, the Bidder agrees that the performance security or portion of the contract amount shall be withheld in favor of the complaining workers pursuant to appropriate provisions of RA No. 12009,

without prejudice to the institution of appropriate actions under the Labor Code, as amended, and other social legislations;

- ii) Comply with Occupational Safety and Health Standards (OSHS) and correct deficiencies, if any.

In case of imminent danger, injury or death of the worker, the Bidder undertakes to suspend contract implementation pending clearance to resume from the DOLE Regional Office, in compliance with the Work Stoppage Order; and

- iii) Inform the workers of their conditions of work, labor clauses under the contract specifying wages, hours of work and other benefits under prevailing national laws, rules and regulations; or CBA or arbitration award, if and when applicable, through posting in two (2) conspicuous places in the establishment's premises.
- k) Ensured that it did not give or pay, directly or indirectly, any commission, amount, fee, or any form of consideration, pecuniary or otherwise, to any person or official, personnel or representative of the government in relation to any procurement project or activity;
 - l) Examined all instructions, forms, terms, and specifications in the Bidding Documents;
 - m) Determined and complied with all matters pertaining to the contract to be bid, including but not limited to: (i) the location and the nature of the contract, project, or work; (ii) climatic conditions; (iii) transportation facilities; (iv) nature and condition of the terrain, geological conditions at the site communication facilities, requirements, location and availability of construction aggregates and other materials, labor, water, electric power and access roads; and (v) other factors that may affect the cost, duration and execution or implementation of the contract, project, or work; and
 - n) Ensured that all information in the Bidding Documents, including bid or supplemental bid bulletin(s) issued, are correct and consistent. The Procuring Entity shall not assume any responsibility regarding erroneous interpretations or conclusions by the prospective or eligible Bidder out of the data furnished by the Procuring Entity.

Failure to observe any of the above responsibilities shall be at the risk of the Bidder concerned;

6.4 The Bidder, by the act of submitting its bid, shall be deemed to have inspected the site, determined the general characteristics of the contract works and the conditions for this Project and examine all instructions, forms, terms, and project requirements in the Bidding Documents.

6.5 Further, the Bidder shall bear all costs associated with the preparation and submission of its bid, and the Procuring Entity shall in no case be responsible or liable for those costs, regardless of the conduct or outcome of the bidding process.

In case of failure of bidding, the Bidding Documents fee may be applied in the re-bidding for the same Project.

- 6.6 Furthermore, the Bidder should be aware that the Procuring Entity will accept bids only from those that have paid the applicable fee for the Bidding Documents at the office indicated in the Invitation to Bid.

7) Origin of Goods and Services

Unless otherwise indicated in the **BDS**, there is no restriction on the origin of Goods, or Contracting of Works or Services other than those prohibited by a decision of the United Nations Security Council taken under Chapter VII of the Charter of the United Nations.

8) Subcontracts

- 8.1 Unless otherwise specified in the **BDS**, the Bidder may subcontract portions of the Works to an extent as may be approved by the HoPE and as stated in the **BDS**. However, the subcontracted portion shall not exceed fifty (50%), or a different percentage of the ABC, on a per project basis, as approved by the GPPB.
- 8.2 Subcontracting of any portion of the Project shall not relieve the Bidder from any liability or obligation that may arise from the contract.
- 8.3 Subcontractors must meet the eligibility criteria as stated in the **BDS** and shall submit the same eligibility documents as the general contractor. Failure of a subcontractor to meet the eligibility criteria does not affect the eligibility of the general contractor for the procurement project. In such case, the portion intended to be subcontracted to the ineligible subcontractor shall be assumed by the general contractor.
- 8.4 Subcontracting arrangement, if allowed, including the time of submission of the eligibility documents of the subcontractor, shall be disclosed in the **BDS**.

B. Contents of Bidding Documents

9) Pre-Bid Conference

- 9.1 If so specified in the **BDS**, a pre-bid conference shall be held either at the Procuring Entity's physical address and/or online through videoconferencing, webcasting, or similar technology, or a combination thereof, on the date indicated therein, to clarify and address the Bidders' questions on the technical and financial components of this Project.
- 9.2 The pre-bid conference shall be held at least twelve (12) calendar days before the deadline for the submission of and receipt of bids, but not earlier than seven (7) calendar days from the posting of the invitation to bid and other bidding documents on the PhilGEPS website.
- 9.3 Bidders are highly encouraged to attend the pre-bid conference to fully understand the Procuring Entity's requirements. While non-attendance of the Bidder will in no way prejudice its bid, the Bidder is deemed to know any changes and/or amendments to the Bidding Documents, as may be provided in the Supplemental Bid Bulletin.

The proceedings of the pre-bid conference shall be recorded, and the corresponding minutes shall be prepared not later than five (5) calendar days after the pre-bid conference. The minutes shall be made available to prospective Bidders not later than five (5) days upon written request.

- 9.4 Decisions of the BAC amending any provision of the Bidding Documents shall be issued in writing through a Supplemental Bid Bulletin at least seven (7) calendar days before the deadline for the submission and receipt of bids.

10) Clarification and Amendment of Bidding Documents

- 10.1 Prospective bidders may request for clarification(s) on and/or interpretation of any part of the Bidding Documents. Such a request must be in writing and submitted to the BAC of the Procuring Entity at the address or electronic mail indicated in the **BDS** or through the electronic bidding facility of PhilGEPS, as may be applicable, at least ten (10) calendar days before the deadline set for the submission and receipt of Bids.
- 10.2 The BAC shall respond to the said request by issuing a Supplemental Bid Bulletin duly signed by the BAC Chairperson. It shall be made available to all those who have properly secured the Bidding Documents, at least seven (7) calendar days before the deadline for the submission and receipt of Bids.
- 10.3 Supplemental Bid Bulletins may also be issued upon the Procuring Entity's initiative for purposes of clarifying or modifying any provision of the Bidding Documents not later than seven (7) calendar days before the deadline for the submission and receipt of Bids. Any modification to the Bidding Documents shall be identified as an amendment.
- 10.4 Any Supplemental Bid Bulletin issued by the BAC shall also be posted on the PhilGEPS website, in any conspicuous place in the premises of the Procuring Entity, and on the website or social media platforms of the Procuring Entity, if available, or such other channels as may be authorized by the GPPB. It shall be the responsibility of all prospective bidders, including those who have properly secured the Bidding Documents, to inquire and secure Supplemental Bid Bulletins that may be issued by the BAC. However, Bidders who have submitted bids before the issuance of the Supplemental Bid Bulletin must be accordingly informed by the BAC, and be allowed to modify or withdraw their bids prior to the deadline for the submission and receipt of bids in accordance with ITB Clause 21.

C. Preparation of Bids

11) Language of Bids

The eligibility requirements or statements, the bids, and all other documents to be submitted to the BAC must be in English. If the eligibility requirements or statements, the bids, and all other documents submitted to the BAC are in foreign language other than English, it must be accompanied by a translation of the documents in English. The documents shall be translated by the relevant foreign government agency, the foreign government agency authorized to translate documents, or a registered translator in the foreign bidder's country. The Bidder shall cause the authentication of the translated documents and shall be authenticated by the appropriate Philippine foreign service establishment or post or the equivalent office having jurisdiction over the foreign bidder's affairs in the Philippines. However, for Contracting Parties to the

Apostille Convention, the documents shall be authenticated through an apostille by the Competent Authority, as defined in Section 20.2.9.2 of the IRR, except for countries identified by the DFA that will still require legalization (red ribbon) by the relevant Embassy or Consulate. The English translation shall govern, for purposes of interpretation of the bid.

12) Documents Comprising the Bid: Technical and Financial Components

12.1 The first bid envelope shall contain the following technical documents, including the eligibility documents:

- a) PhilGEPS Certificate of Registration (Platinum Membership) in accordance with Section 20 of the IRR;
- b) PCAB License and Registration, in case of Joint Venture (JV);
- c) Statement of all its ongoing government and private contracts, including contracts awarded but not yet started, if any, whether similar or not similar in nature and complexity to the contract to be bid;
- d) Statement of the Bidder's SLCC, in accordance with **ITB** Clause 5.5.

The SLCC shall be supported by an Owner's Certificate of Final Acceptance issued by the project owner other than the Contractor, or a final rating of at least satisfactory in the CPES, or a similar performance and monitoring system. In case of contracts with the private sector, an equivalent document shall be submitted;

- e) NFCC computation in accordance with **ITB** Clause 5.6;
- f) Joint Venture Agreement (JVA), if applicable;
- g) Bid Security in the prescribed form and amount in accordance with **ITB** Clause 16, and validity period under **ITB** Clause 15;
- h) Project Requirements, which shall include the following:
 - i) Organizational chart of the personnel to be deployed for the procurement project to be bid;
 - ii) List of Contractor's personnel (e.g., Project Manager, Project Engineers, Materials Engineers, and Foremen), to be assigned to the procurement project to be bid, with their complete qualifications and experience data. These personnel must meet the required minimum years of experience set in the **BDS**;
 - iii) List of Contractor's major equipment units which are owned, leased, or under purchase agreements, supported by proof of ownership or certification of availability of equipment from the equipment lessor or vendor for the duration of the project, as the case may be, which must meet the minimum requirements for the contract set in the **BDS**; and
 - iv) Omnibus Sworn Statement in accordance with Section 54.3 of the IRR.

- 12.2 The second bid envelope shall contain the Financial Bid Form, which includes the bid prices and the bill of quantities, in accordance with **ITB** Clauses 13.1.
- 12.3 Whenever necessary, modifications may be made to the foregoing provisions specifically for major and specialized procurement to suit the particular needs of the Procuring Entity, subject to the approval of the GPPB.
- 12.4 All bids that exceed the ABC shall not be accepted. Unless otherwise indicated in the **BDS**, for foreign-funded procurement, the ABC shall be applied as the ceiling to bid prices provided the following conditions are met:
- a) Bidding Documents are obtainable free of charge on a freely accessible website. If payment of Bidding Documents is required by the Procuring Entity, payment could be made upon the submission of bids.
 - b) The Procuring Entity has procedures in place to ensure that the ABC is based on recent estimates made by the engineer or the responsible unit of the Procuring Entity and that the estimates are based on adequate detailed engineering and reflect the quality, supervision and risk, and inflationary factors, as well as prevailing market prices, associated with the types of works or goods to be procured.
 - c) The Procuring Entity has trained cost estimators on estimating prices and analyzing bid variances. In the case of Infrastructure Projects, the Procuring Entity must also have trained quantity surveyors.
 - d) The Procuring Entity has established a system to monitor and report bid prices relative to ABC and engineer's or Procuring Entity's estimate.
 - e) The Procuring Entity has established a monitoring and evaluation system for contract implementation to provide feedback on actual total costs of goods and works.

However, the GoP and the foreign government, or foreign or international financing institutions may agree to waive the foregoing conditions.

13) Bid Prices

- 13.1 The contract shall be for the whole Works, as described in the Bidding Documents, based on the priced Bill of Quantities submitted by the Bidder.
- 13.2 The Bidder shall fill in rates and prices for all items of the Works described in the Bill of Quantities. In case partial bids are allowed in the ITB, bids not addressing or providing all of the required items in the Bidding Documents including, where applicable, the Bill of Quantities, shall be considered non-responsive and shall be automatically disqualified. In this regard, where a required item is provided, but no price is indicated, the same shall be considered as non-responsive, but specifying a zero (0) or a dash (-) for the said item would mean that it is being offered for free to the Government, except those required by law or regulations to be provided for.
- 13.3 For the given scope of work in the contract as awarded, all bid prices shall be considered as fixed prices, and therefore not subject to price escalation during contract implementation, except under extraordinary circumstances as specified in GCC Clause 45.

14) Bid Currencies

- 14.1 All bid prices shall be quoted in Philippine Peso unless otherwise provided in the **BDS**. However, for purposes of bid evaluation, bids denominated in foreign currencies shall be converted to Philippine currency based on the exchange rate as published in the BSP Daily Reference Exchange Rate Bulletin on the day of the bid opening.⁴
- 14.2 If so allowed in accordance with **ITB** Clause 14.1, the Procuring Entity, for purposes of bid evaluation and comparing the bid prices, will convert the currencies in which the bid price is expressed to Philippine Peso at the foreign exchange rates.
- 14.3 Unless otherwise specified in the **BDS**, payment of the contract price shall be made in Philippine Peso.

15) Bid Validity

- 15.1 Bids shall remain valid for the period specified in the **BDS** which shall not exceed one hundred twenty (120) calendar days from the date of the opening of bids.
- 15.2 Should it become necessary to extend the validity of the bids and the bid securities beyond one hundred twenty (120) calendar days, the Procuring Entity concerned shall request in writing all those who submitted bids for such extension before the expiration date therefor. Bidders, however, shall have the right to refuse to grant such extension without forfeiting their Bid Security.

16) Bid Security

- 16.1 The Bidder, at its option, shall submit a Bid Security in the form and amount as stated in the **BDS**, which may include the following:

Form of Bid Security	Amount of Bid Security (Not less than the required Percentage of the ABC)
(a) Cash or cashier's/manager's check issued by a bank. <i>For biddings conducted by LGUs, the Cashier's or Manager's check may be issued by other banks certified by the BSP as authorized to issue such financial instrument.</i>	Two percent (2%)
(b) Bank draft/guarantee or irrevocable Letter of Credit issued by a bank; Provided, however, that it shall be confirmed or authenticated by a	Five percent (5%)

⁴ RA No. 8183 or "An Act to Assure Uniform Value to Philippine Coin and Currency."

<p>local bank, if issued by a foreign bank.</p> <p><i>For biddings conducted by LGUs, the Bank Draft/ Guarantee, or irrevocable letter of credit may be issued by other banks certified by the BSP as authorized to issue such financial instrument.</i></p>	
<p>(c) Surety bond callable upon demand issued by a surety or insurance company duly certified by the Insurance on as authorized to issue such security.</p>	<p>Five percent (5%)</p>
<p>(d) Bid Securing Declaration</p>	<p>Not Applicable</p>

The Bid Security shall be denominated in Philippine Peso and posted in favor of the Procuring Entity.

- 16.2 The Bid Security should be valid for the period specified in the **BDS**. Any bid not accompanied by an acceptable Bid Security shall be considered as non-responsive and rejected by the Procuring Entity.
- 16.3 In no case shall the Bid Security be returned later than the expiration of the bid validity period indicated in the Bidding Documents, unless it has been extended in accordance with Section 57.2 of the IRR. In case the bidder is required to extend its bid validity, the bidder may, at its discretion, substitute a Bid Securing Declaration for the extended period as a replacement of its Bid Security; Provided, that the option to substitute is indicated in the **BDS**.
- 16.4 Upon signing and execution of the contract, pursuant to **ITB** Clause 29, and the posting of the performance security pursuant to **ITB** Clause 30, the Bid Security of the successful Bidder's Bid Security will be discharged, but in no case later than its validity period as indicated in **ITB** Clause 15.
- 16.5 The Bid Security may be forfeited based on any of the following grounds, as provided under Rule VIII, X, XI, and XXI of the IRR:
- a) If a Bidder:
 - i) With the Lowest Calculated Responsive Bid (LCRB), Most Economically Advantageous Responsive Bid (MEARB), Most Advantageous Responsive Bid (MARB), Single Calculated and Responsive Bid (SCRB), Single Economically Advantageous Responsive Bid (SEARB), or Single Advantageous Responsive Bid (SARB) withdraws, fails, refuses or is unable to: (i) submit the documents required under Section 66.5 of the IRR; (ii) enter into contract with the Procuring Entity; or (iii) post the required performance security within the period stipulated in the IRR and in accordance with **ITB** Clause 30;

- ii) Causes the delay, without justifiable cause, of the screening for eligibility, opening of bids, evaluation and post evaluation of Bids, and awarding of contracts;
- iii) Refuses to clarify or validate in writing its bid during post-qualification within a period of seven (7) calendar days from receipt of the request for clarification;
- iv) Withdraws a bid, or refuses to accept an award, or refuses or fails to enter into contract with the Procuring Entity without justifiable cause, after the approval of the HoPE for having been the declared LCRB or MEARB, as the case may be;
- v) Refuses or fails to furnish performance security within the prescribed time;
- vi) Commits of three (3) or more of any of the acts imposed with suspension, as provided under Section 99 of the IRR;
- vii) Uses force, fraudulent machinations, coercion, undue influence or pressure on any member of the BAC or any officer or employee of the Procuring Entity to take a particular action for its own favor or gain, or to the advantage of a particular bidder;
- viii) Colludes with one (1) or more bidders and submitting different bids as if they were bona fide, when they knew that one or more of them was so much higher than the other that it could not be honestly accepted and that the contract will surely be awarded to the pre-arranged lowest bid;
- ix) Maliciously submits different bids through two (2) or more persons, corporations, partnerships, or any other business entity in which it has interest, to create the appearance of competition that does not in fact exist so as to be declared as the winning bidder;
- x) Enters into an agreement with other bidder/s which call upon one to refrain from bidding for procurement contracts, or which call for withdrawal of bids already submitted, or which are otherwise intended to secure an undue advantage to any of the bidders;
- xi) Fails to faithfully disclose its relationship, regardless of the time of its discovery, with the HoPE, members of the BAC, the TWG, and the BAC Secretariat, the head of the PMO or the End-User or Implementing Unit, and the project consultants of the Procuring Entity, or of the procurement agent, whichever is applicable, by consanguinity or affinity up to the third civil degree pursuant to Section 81 of the IRR;
- xii) Submits beneficial ownership information containing false entries;
- xiii) Allows the use of one's name or uses the name of another for purposes of public bidding;

- xiv) Submits eligibility requirements and bids containing false information or falsified documents or the concealment of such information that will materially alter the outcome of eligibility screening or any stage of the procurement;
 - xv) Accesses the contents of any Bid submitted to the Procuring Entity before the opening of bids, without authorization;
 - xvi) Has any documented attempt to unduly influence the outcome of the bidding;
 - xv) Employs schemes which stifle or suppress any procurement activity; or
 - xvi) Commits a third offense imposed with blacklisting under the Act by the same Procuring Entity, or a combination of three (3) violations imposed with blacklisting by the Procuring Entity and other Procuring Entities, as posted on the GPPB portal;
- b) If a Winning Bidder:
- i) Conducts poor performance or unsatisfactory quality and/or progress of work. Poor performance shall be as follows:
 - i.i) Negative slippage of fifteen percent (15%) and above within the critical path of the project due entirely to the fault or negligence of the winning bidder; or
 - i.ii) Non-compliance of the materials and workmanship with the approved specifications arising from the fault or negligence of the winning bidder.
 - ii) In case it is determined prima facie that the winning bidder has engaged, before or during the implementation of the contract, in the following unlawful deeds and behaviors relative to contract acquisition and implementation:
 - ii.i) Corrupt, fraudulent, collusive and coercive practices;
 - ii.ii) Drawing up or using forged documents; or
 - ii.iii) Using adulterated materials, means or methods, or engaging in production contrary to rules of science or trade.
 - iii) Assigns or subcontracts the contract or any part thereof or substituting key personnel named in the proposal without prior written approval by the Procuring Entity;
 - iv) Willfully or deliberately abandons or does not perform the project or contract by the winning bidder resulting in substantial breach thereof without lawful and/or just cause;
 - v) Has its contract terminated due to its default or unlawful acts; or

- vi) Fails to comply with the provision on warranty that requires to repair any noted defect or damage to the Infrastructure Project due to the use of materials of inferior quality within ninety (90) calendar days from the issuance of the order by the HoPE to undertake such repairs.

17) Format and Signing of Bids

- 17.1 Bidders shall submit their bids through their duly authorized representative using the appropriate forms provided in Section IX. Philippine Bidding Documents Related Forms on or before the deadline specified in the **ITB** Clause 19 in two (2) separate sealed bid envelopes which shall be submitted simultaneously, whether through manual or online submission. The first shall contain the technical component of the bid, including the eligibility requirements under **ITB** Clause 12, and the second shall contain the financial component of the bid.
- 17.2 Forms as mentioned in **ITB** Clause 17.1 must be completed without any alterations to their format. No substitute form shall be accepted.
- 17.3 Each and every page of the Bid Form, including the Bill of Quantities, under Section IX hereof, shall be signed by the duly authorized representative/s of the Bidder. Failure to do so shall be a ground for the rejection of the bid.
- 17.4 Any insertions, erasures, or overwriting shall be valid only if they are signed or initialed by the duly authorized representative/s of the Bidder.

18) Sealing and Marking of Bids

- 18.1 Bidders shall enclose their technical documents described in **ITB** Clause 12 in one sealed envelope marked "TECHNICAL COMPONENT," and the financial component in another sealed envelope marked "FINANCIAL COMPONENT," sealing them all in an outer envelope marked "BID."
- 18.2 The Bid shall be typed or written in ink and shall be signed by the Bidder or its duly authorized representative/s.
- 18.3 All envelopes shall:
 - a) contain the name of the contract to be bid in capital letters;
 - b) bear the name and address of the Bidder in capital letters;
 - c) be addressed to the Procuring Entity's BAC in accordance with **ITB** Clause 18.1;
 - d) bear the specific identification of this bidding process indicated in the **ITB** Clause 1.1; and
 - e) bear a warning "DO NOT OPEN BEFORE..." the date and time for the opening of bids, in accordance with **ITB** Clause 19.
- 18.4 For manually submitted bid envelopes that are not properly sealed and marked, as required in the Bidding Documents, the same shall be accepted; Provided, That the bidder or its duly authorized representative shall acknowledge such

condition of the bid as submitted. On the other hand, unsealed or unmarked bid envelopes, or bids that cannot be opened or corrupted in case of online submission, shall be rejected.

The BAC shall assume no responsibility for misplaced or lost contents of the improperly sealed or marked bid, or for its premature opening.

D. Submission and Opening of Bids

19) Deadline for Submission of Bids

Bids must be received by the Procuring Entity's BAC at the address indicated in the **Invitation to Bid**, or through the e-bidding facility of the PhilGEPS, on or before the date and time indicated in the **BDS**.

20) Late Bids

Bids, including the eligibility requirements, submitted after the deadline shall be rejected by the BAC. The BAC shall record in the Minutes of the Meeting the submission and opening of bids, the Bidder's name, its representative, and the time the late bid was submitted.

21) Modification and Withdrawal of Bids

21.1 Bidders may modify their bids before the deadline for the submission and receipt of bids.

a) For manual submission and receipt of bids, the Bidders shall not be allowed to retrieve their original bid, but shall only be allowed to submit the bid modification by sending another bid, equally sealed, properly identified, linked to its original bid, and marked as a "modification," thereof, and stamped "received" by the BAC. Bid modifications received after the applicable deadline shall not be considered and shall be returned to the bidder unopened.

b) For online submission of bids, the Bidders shall not be allowed to retrieve their original Bid, but shall only be allowed to submit the bid modification, send another Bid equally secured, properly identified labelled as a "modification" of the one previously submitted. The time indicated in the latest bid receipt page generated shall be the official time of submission. Bids modification submitted after the applicable deadline shall not be accepted.

21.2 Bidders may withdraw their bids in writing before the deadline for submission and receipt of bids. Withdrawal of bids after the applicable deadline shall be subject to appropriate sanctions as prescribed in the IRR.

Bidders may also express their intention not to participate in the bidding in writing, which should be received by the BAC before the deadline for submission and receipt of bids. Bidders that withdraw their bids shall no longer be allowed to submit another bid for the same contract, directly or indirectly.

21.3 No bid may be modified after the deadline for submission and receipt of bids. Further, no bid may be withdrawn in the interval between the deadline for submission and receipt of bids, and the expiration of bid validity specified by

the Bidder in the Financial Bid Form. Withdrawal of bid during this interval shall result in the forfeiture of the Bidder's Bid Security pursuant to **ITB** Clause 16.5, and the imposition of administrative sanctions as prescribed by RA No. 12009 and without prejudice to the imposition of civil and criminal sanctions as provided under applicable laws.

Alternative Bids shall be rejected. For this purpose, Alternative Bid shall pertain to an offer made by a bidder in addition or as a substitute to its original bid, which may be included as part of its original bid or submitted separately. A bid with options shall likewise be considered an Alternative Bid regardless of whether said bid proposal is contained in a single envelope or submitted in two (2) or more separate bid envelopes.

Bidders shall submit offers that comply with the requirements of the Bidding Documents, including the basic technical design as indicated in the drawings and specifications. Unless there is a value engineering clause in the **BDS**, alternative bids shall not be accepted.

Each Bidder shall submit only one Bid, either individually or as a partner in a JV. A Bidder who submits or participates in more than one bid (other than as a subcontractor if a subcontractor is permitted to participate in more than one bid) will cause all the proposals with the Bidder's participation to be disqualified. This shall be without prejudice to any applicable criminal, civil and administrative penalties that may be imposed upon the persons and entities concerned.

22) Opening and Preliminary Examination of Bids

- 22.1 The BAC shall open the bids in public, immediately after the deadline for submission and receipt of bids, as specified in the **BDS**. In case the Bids cannot be opened as scheduled due to justifiable reasons, the BAC shall take custody of the submitted Bids and reschedule the opening of Bids on the next working day or at the soonest possible time, through the issuance of a Notice of Postponement to be posted on the PhilGEPS website and the website of the Procuring Entity concerned.
- 22.2 The manner of opening of the bids for Infrastructure Projects shall depend on the award criterion to be adopted, as follows:
 - a) For LCRB and MEARB, the BAC shall open the technical and financial proposals on the same day; and
 - b) For MARB, only the technical proposals shall be opened while the financial proposals shall remain unopened and shall be kept securely by the BAC until the specified time of their opening as indicated in the **BDS**. Only the financial proposals of the bidders who have met the highest technical score for MAB shall be opened.
- 22.3 The Procuring Entity shall prepare the minutes of the proceedings of the bid opening that shall include, as a minimum: (a) names of Bidders, their bid price (per lot, if applicable, and/or including discount, if any), bid security, findings of preliminary examination, and whether there is a withdrawal or modification; and (b) attendance sheet. The BAC members shall sign the abstract of bids as read.

- 22.4 The Bidders or their duly authorized representatives may attend the opening of bids. The BAC shall ensure the integrity, security, and confidentiality of all submitted bids. The Abstract of bids, as read, and the minutes of the bid opening shall be made available to the public, upon written request and payment of a specified fee to recover the cost of materials.
- 22.5 To ensure transparency and accurate representation of the bid submission, the BAC Secretariat shall notify in writing all bidders whose bids it has received through mail at its PhilGEPS-registered physical address or official e-mail address. The said notice shall be issued within seven (7) calendar days from the date of the bid opening.

E. Evaluation and Comparison of Bids

23) Process to be Confidential

- 23.1 Members of the BAC, its staff and personnel, Secretariat, and TWG, as well as Observers, are prohibited from making or accepting any communication with any bidder regarding the evaluation of their bids until the issuance of the Notice of Award, unless otherwise allowed in the case of **ITB** Clause 24.
- 23.2 Any effort by a Bidder to influence the Procuring Entity in the Procuring Entity's decision in respect of bid evaluation, bid comparison or contract award will result in the rejection of the bid.

24) Clarification of Bids

To assist in the evaluation, comparison, and post-qualification of the bids, the Procuring Entity may ask in writing any Bidder for a clarification of its bid. All responses to requests for clarification shall be in writing. Any clarification submitted by a Bidder in respect to its bid that is not in response to the request of the Procuring Entity shall not be considered.

25) Detailed Evaluation and Comparison of Bids

- 25.1 The Procuring Entity's evaluation of bids shall be based on the bid price quoted in the Bid Form, which includes the Bill of Quantities.
- 25.2 The Procuring Entity will undertake the detailed evaluation and comparison of the bids which have passed the opening and preliminary examination of bids, pursuant to **ITB** Clause 22, to determine the Lowest Calculated Bid (LCB), Most Economically Advantageous Bid (MEAB), and Most Advantageous Bid (MAB).
- 25.3 The award criterion shall be determined as follows:
- a) For LCB:
 - i) The detailed evaluation of the financial component of the bids, to establish the correct calculated prices of the bids; and
 - ii) The ranking of the total bid prices as so calculated from the lowest to highest, where the bid with the lowest price shall be identified as the LCB.

- b) For MEAB, the BAC shall evaluate the quality and price proposals to determine the MEAB using the following steps:
- i) The quality proposal together with the price proposal shall be considered in the evaluation of bids. The quality proposals shall be evaluated first using the criteria in the **BDS**. The price proposals of the bids that meet the minimum quality score shall then be opened.
 - ii) The price and quality proposals shall be given corresponding weights with the price proposal given a minimum weight of fifteen percent (15%) up to a maximum of forty percent (40%). The weight of the quality criteria shall be adjusted accordingly such that their total weight in percent together with the weight given to the price proposal shall be equal to one hundred percent (100%).
 - iii) To further promote green public procurement, the sustainability of materials or structures with green specifications shall be given greater weight in the evaluation of bids. As approved by the BAC, the exact weights shall be indicated in the **BDS**. The BAC shall rank the bidders in descending order based on the combined numerical ratings of their quality and price proposals. The bidder with the best overall score using the quality-price ratio shall be referred to as the MEAB.
 - iv) The HoPE shall approve or disapprove the recommendations of the BAC within two (2) calendar days after receipt of the results of the evaluation from the BAC.

The quality component shall be assessed on the basis of criteria with corresponding numerical weights indicated in the **BDS**, which may include qualitative, environmental, or social aspects linked to the subject matter of the contract. These may include any or a combination of the following:

- a) Quality and technical merit, including technical competence and a credible track record;
- b) Aesthetic and functional design and characteristics;
- c) Approach and methodology;
- d) Accessibility;
- e) Tools and equipment;
- f) Social, environmental, economic, and innovative characteristics;
- g) Organization, qualification, and experience of employees or staff assigned to perform the contract;
- h) Ongoing contracts and work commitments; or
- i) Other relevant criteria in relation to the subject Infrastructure Projects to be procured.

c) For MAB

- i) The BAC shall evaluate the quality proposals to determine the MAB using the quality components. The quality components shall be assessed on the basis of the criteria with corresponding numerical weights indicated in the **BDS** to determine the bidder with the highest technical rating.
 - ii) The second bid envelope of the bidder obtaining the highest technical rating shall be opened. If the financial proposal is equal to or lower than the ABC, the bid shall be accepted and determined as the MAB; otherwise, the same shall be rejected and the bidder will be disqualified.
- 25.4 In order to eliminate bias in evaluating the quality proposals, it is recommended that the highest and lowest scores for each bidder for each criterion shall not be considered in determining the average scores of the bidders, except when the evaluation is conducted in a collegial manner.
- 25.5 The BAC shall immediately conduct a detailed evaluation of all bids using non-discretionary criteria in considering the following:
 - a) Completeness of the bid. Unless the **BDS** allows partial bids, bids not addressing or providing all of the required items in the BDS shall be considered non-responsive and, thus, automatically disqualified.

However, when no price or a zero (0) or a dash (-) is indicated in a required item in the bid form, the same shall be construed that it is being offered for free to the Government, except those required by law or regulations to be provided for; and
 - b) Arithmetical corrections. The BAC shall consider computational errors and omissions to enable proper comparison of all eligible bids. It may also consider bid correction if expressly allowed in the **BDS**. Any adjustment shall be calculated in monetary terms to determine the calculated prices.
- 25.6 Based on the detailed evaluation of bids, those that comply with the above-mentioned requirements shall be ranked in the ascending order of their total calculated bid prices, as evaluated and corrected for computational errors, discounts and other modifications, to identify the LCB, MEAB, or MAB. Total calculated bid prices, as evaluated and corrected for computational errors, discounts and other modifications, which exceed the ABC shall not be considered, unless otherwise indicated in the **BDS**.
- 25.7 The BAC shall evaluate all bids on an equal footing to ensure fair and competitive bid comparison. For this purpose, all bidders shall be required to include in their bids the cost of all taxes, such as, but not limited to, value-added tax (VAT), income tax, local taxes, and other fiscal levies and duties. Such bids, including said taxes, shall be the basis for the bid evaluation and comparison.
- 25.8 If so indicated pursuant to **ITB** Clause 1.1, bids may be submitted for individual lots, or for any combination thereof, provided that all bids and combinations of bids shall be received by the same deadline and opened and evaluated simultaneously so as to determine the bid or combination of bids offering the lowest calculated cost to the Procuring Entity. Bid prices quoted shall correspond to all of the requirements specified for each lot. Bid Security as

required by **ITB** Clause 16 shall be submitted for each contract (lot) separately. The basis for evaluation of lots is specified in **BDS** Clause 25.5 (a).

26) Post - Qualification

- 26.1 The BAC shall determine to its satisfaction whether the Bidder that is evaluated as having submitted the LCB, MEAB, or MAB, as the case may be, complies with and is responsive to all the requirements and conditions specified in **ITB** Clauses 5 and 12. The Bidder, within a non-extendible period of five (5) calendar days from receipt of notice from the BAC that it submitted the LCB, MEAB, or MAB, shall submit all the eligibility documents supporting its PhilGEPS Certificate of Registration (Platinum Membership), its latest income and business tax returns filed for the preceding quarter which should not be earlier than two (2) quarters from the date of submission and receipt of bid, and other appropriate licenses and permits required by law and stated in the **BDS**.
- 26.2 Failure to submit any of the post-qualification requirements on time, or a finding against the veracity thereof, shall disqualify the Bidder for award; Provided, That in the event that a finding against the veracity of any of the documents submitted is made, it shall cause the forfeiture of the Bid Security.
- 26.3 The determination shall be based upon an examination of the documentary evidence of the Bidder's qualifications submitted pursuant to **ITB** Clause 12, as well as other information as the Procuring Entity deems necessary and appropriate, using a non-discretionary "pass/fail" criterion, which shall be completed within a period of twelve (12) calendar days.
- 26.4 If the BAC determines that the bidder with the LCB, MEAB, or MAB passes all the criteria for post-qualification, it shall declare the said bid as the LCRB, MEARB, MARB, SCB, SEAB, or Single Advantageous Bid (SAB) and recommend to the HoPE the award of contract to the said bidder at its submitted bid price or its calculated bid price, whichever is lower or, in the case of quality-based evaluation procedure, submitted bid price or its negotiated price, whichever is lower.
- If, however, the BAC determines that the bidder with the LCB, MEAB, MAB, SCB, SEAB, or SAB fails to meet the post-qualification criteria, it shall immediately notify the Bidder in writing of its post-disqualification and the grounds for such determination.⁵
- 26.5 Immediately after the BAC has notified the first bidder of its post-disqualification, and notwithstanding any pending request for reconsideration thereof, the BAC shall initiate and complete the same post-qualification process on the bidder with the second LCB, MEAB, or MAB. If the second bidder passes the post-qualification and provided that the request for reconsideration of the first bidder has been denied, the second bidder shall be post-qualified as the bidder with the LCB, MEAB, or MAB.
- 26.6 If the second bidder, however, fails the post-qualification, the procedure for post-qualification shall be repeated for the bidder with the next LCB, MEAB, or MAB and so on, until the LCRB, MEARB, or MARB, as the case may be, is

⁵ Sec 63.5 of the IRR.

determined for award, subject to the procedure of Notice and Execution of Award.

- 26.7 Within a period not exceeding ten (10) calendar days from the determination by the BAC of the LCRB, MEARB, MARB, SCRIB, SEARB, or SARB and the recommendation to award the contract, the HoPE or its duly authorized representative shall approve or disapprove the said recommendation.
- 26.8 In case of approval, the HoPE or its duly authorized representative shall immediately issue the Notice of Award to the bidder with the LCRB, MEARB, MARB, SCRIB, SEARB, or SARB, as the case may be.

In the event that the approving authority shall disapprove the resolution on the award of the contract, such disapproval shall be based only on valid, reasonable, and justifiable grounds as enumerated under Section 70 of the IRR to be expressed in writing. A copy of the decision disapproving the resolution shall be furnished to the BAC and the bidder.

27) Reservation Clause

- 27.1 Notwithstanding the eligibility or post-qualification of a bidder and without incurring any liability, the HoPE or its duly authorized representative at any stage of the procurement, reserves the right to review its qualifications, reject any and all bids, declare a failure of bidding or not award the contract in the following situations:
 - a) If it has reasonable grounds to believe that a misrepresentation has been made by the said bidder; or
 - b) If it has reasonable grounds to believe that there has been a change in the bidder's capability to undertake the project from the time it submitted its eligibility requirements.

Should such review uncover any misrepresentation made in the eligibility and bidding requirements, statements or documents, or any changes in the situation of the Bidder which will adversely affect its capability to undertake the Project so that it no longer meets the prescribed eligibility or bid evaluation criteria, the Procuring Entity shall consider the said Bidder as ineligible and disqualify it from participating further in the bidding process or being awarded the contract.

- 27.2 Based on the following grounds, the HoPE or its duly authorized representative reserves the right to reject any and all Bids, declare a Failure of Bidding at any time prior to the contract award, or not to award the contract, without thereby incurring any liability, and make no assurance that a contract shall be entered into as a result of the bidding:
 - a) If there is *prima facie* evidence of collusion between appropriate public officers or employees of the Procuring Entity, or between the BAC and any of the bidders, or if the collusion is between or among the bidders themselves, or between a bidder and a third party, including any act which restricts, suppresses or nullifies or tends to restrict, suppress or nullify competition or influences or tends to influence the bidding process;

- b) If the BAC is found to have failed in complying with the applicable law or in following the prescribed bidding procedures; or
- c) If there are any justifiable and reasonable ground where the award of the contract will not redound to the benefit of the government, in instances where (i) the physical and economic conditions have significantly changed so as to render the project no longer economically, financially or technically feasible as determined by the HoPE; (ii) the Project is no longer necessary as determined by the HoPE; and (iii) the source of funds for the Project has been withheld or reduced through no fault of the Procuring Entity.

F. Award of Contract

28) Contract Award

- 28.1 Subject to **ITB** Clause 26, the HoPE or its duly authorized representative shall award the contract to the Bidder whose bid has been determined to be the LCRB, MEARB, MARB, SCRB, SEARB, or SARB, as the case may be.
- 28.2 Prior to the expiration of the period of bid validity, the Procuring Entity shall notify the winning Bidder in writing that its bid has been accepted, through a Notice of Award duly received by the Bidder or its representative personally or by registered mail or electronically, receipt of which must be confirmed in writing within two (2) days by the Bidder with the LCRB, MEARB, MARB, SCRB, SEARB, or SARB, as applicable, and submitted personally or sent by registered mail or electronically to the Procuring Entity.
- 28.3 Within ten (10) calendar days from receipt by the winning bidder of the Notice of Award, the following conditions should be complied with before the contract may be awarded:
 - a) Submission of the following documents:
 - i) Valid JVA, if applicable;
 - ii) The SEC Certificate of Registration of the foreign corporation, if applicable; or
 - iii) Valid PCAB license and registration for the type and cost of the Project for foreign bidders when the Treaty or International or Executive Agreement expressly allows submission of such license and registration as a pre-condition to the Notice of Award.
 - b) Posting of the performance security in accordance with **ITB** Clause 30; and
 - c) Signing of the contract as provided in **ITB** Clause 29.

29) Signing of the Contract

- 29.1 Within ten (10) calendar days from receipt of the Notice of Award, the winning Bidder shall post the required performance security, sign and date the contract, and return it to the Procuring Entity.
- 29.2 The Procuring Entity shall enter into a contract with the successful Bidder within the same ten (10) calendar day period provided that all the documentary requirements are complied with.
- 29.3 The following documents shall form part of the contract:
- a) Contract Agreement;
 - b) Bidding Documents;
 - c) Winning Bidder's bid, including the technical and financial proposals, and all other documents/statements submitted (e.g., Bidder's response to request for clarifications on the bid), including corrections to the bid, if any, resulting from the Procuring Entity's bid evaluation;
 - d) Performance Security;
 - e) Notice of Award of Contract; and
 - f) Other contract documents that may be required by existing laws and/or specified in the **BDS**.

30) Performance Security

- 30.1 To guarantee the faithful performance by the winning bidder of its obligations under the contract, it shall post a performance security prior to the signing of the contract. Furthermore, the successful bidder shall be required to update the performance security posted before to the issuance of a variation order, if any.
- 30.2 Sectors enumerated under Section 76.1⁶ of the IRR may be allowed to post Performance Securing Declaration (PSD) as specified in the **BDS**.

⁶ Section 76.1. *The GPPB, once data is available from relevant agencies, shall maintain a registry of entities belonging to the following sectors:*

a) *Farmers as certified by the Department of Agriculture (DA);*
b) *Fisherfolk as certified by the Bureau of Fisheries and Aquatic Resources (BFAR);*
c) *Persons with disabilities as certified by the National Council for Disability Affairs (NCDA) pursuant to RA No. 7277, otherwise known as the Magna Carta for Disabled Persons, as amended;*
d) *Solo parents as certified by the Department of Social Welfare and Development (DSWD);* e) *Microenterprises and social enterprises as certified by the MSMED Council;*
f) *Startups, spin-offs, and other forms of entity involved in science, technology, and innovation activities as certified by the DTI, DICT, NIC or the Department of Science and Technology (DOST), as may be applicable;*
g) *Cooperatives duly registered with the CDA pursuant to RA No. 6938, otherwise known as the Cooperative Code of the Philippines, as amended; and*
h) *Other relevant sectors as may be determined by the GPPB to ensure inclusivity and diversity in the procurement process.*

30.3 The performance security shall be in a form selected by the Procuring Entity in the amount indicated in the **BDS**, which shall not be less than the percentage of the total contract price in accordance with the following price schedule:

Form of Performance Security	Amount of Performance Security (Not less than the Percentage of the Total Contract Price)
a) Cash or Cashier's or Manager's check issued by a bank. <i>For biddings conducted by LGUs, the cashier's or manager's check may be issued by other banks certified by the BSP as authorized to issue such financial instrument.</i>	Ten percent (10%)
b) Bank draft or guarantee or irrevocable Letter of Credit issued by a local bank. If issued by a foreign bank, it shall be confirmed or authenticated by a local bank.	
c) Surety bond callable upon demand issued by a surety or insurance company duly certified by the IC as authorized to issue such security.	Thirty Percent (30%)

30.4 The performance security shall be denominated in Philippine Peso and posted in favor of the Procuring Entity, which shall be forfeited in the event it is established that the winning bidder is in default in any of its obligations under the contract.

31) Notice to Proceed

The Procuring Entity shall issue the Notice to Proceed to the winning Bidder not later than three (3) calendar days from the date of approval of the contract by the appropriate signatories. All notices called for by the terms of the contract shall be effective only at the time of receipt thereof by the successful Bidder.

32) Protest Mechanism

Decisions of the BAC in all stages of procurement may be protested to the HoPE in accordance with Section 83 of the IRR.

Section III. Bid Data Sheet

Notes on the Bid Data Sheet

This Section is intended to assist the Procuring Entity in providing specific information relative to corresponding clauses in the ITB included in Section II. Instructions to Bidders, and has to be prepared for each specific procurement.

The Procuring Entity should specify in the BDS the information and requirements relevant to the circumstances of the Procuring Entity, including procurement processing details; the applicable rules regarding bid price and currency; and the bid evaluation criteria that will apply to the bids. In preparing Section III, the following aspects should be checked:

- a) Information that specifies and complements provisions of Section II. Instructions to Bidders must be incorporated; and
- b) Amendments and/or supplements, if any, to provisions of Section II. Instructions to Bidders as necessitated by the circumstances of the specific procurement, must also be incorporated.

Bid Data Sheet

ITB Clause										
1.1	<p>The Procuring Entity is Technical Education and Skills Development Authority – Regional Office II.</p> <p>The Project title is Creation of TESDA-ISAT Diploma Center (Rebidding)</p> <p>The identification number of the Contract is TESDAR02-2026-002.</p>									
2	<p>The Funding Source is:</p> <p>2.1 The GOP through the source of funding as indicated below for 2026 in the amount of Forty Million Ten Thousand Pesos Only (Php 40,010,000.00)</p> <p>2.2 The source of funding is:</p> <p style="text-align: center;">a. NGA, the General Appropriations Act or Special Appropriations</p>									
3.1	No further instructions.									
5.2	Bidding is restricted to eligible bidders as defined in ITB Clause 5.2.									
5.4	<p>The required track record shall be the following:</p> <p style="text-align: center;">The Bidder must have completed an SLCC that is similar to the procurement project to be bid, and whose value must be equivalent to at least fifty percent (50%) of the ABC, adjusted to current prices using the Philippine Statistics Authority (PSA) consumer price indices, for the last five years. The bidder must also possess PCAB License Atleast Category B.</p> <p>Contracts similar to the Project shall be those described as follows:</p> <p>Completed or ongoing construction contract that involves the erection, repair, or renovation of an industrial, light industrial, or government/commercial building structure which is primarily designed for technical activities, manufacturing, storage, or assembly, and which possesses a similar level of complexity in terms of design, engineering, and material specifications.</p>									
7	No further instructions.									
8.1	<p>Subcontracting is allowed with a maximum of 10% of the total contract price.</p> <table border="1" style="margin-left: auto; margin-right: auto;"> <thead> <tr> <th style="text-align: center;">No.</th> <th style="text-align: center;">Description</th> <th style="text-align: center;">Qty</th> </tr> </thead> <tbody> <tr> <td style="text-align: center;">1</td> <td>125 KVA Standby Diesel Power Generator</td> <td style="text-align: center;">1</td> </tr> <tr> <td style="text-align: center;">2</td> <td>Laboratory Center Table with End Sink (3600L x 1000W x 900H)</td> <td style="text-align: center;">2</td> </tr> </tbody> </table>	No.	Description	Qty	1	125 KVA Standby Diesel Power Generator	1	2	Laboratory Center Table with End Sink (3600L x 1000W x 900H)	2
No.	Description	Qty								
1	125 KVA Standby Diesel Power Generator	1								
2	Laboratory Center Table with End Sink (3600L x 1000W x 900H)	2								

	<table border="1"> <tr> <td>3</td> <td>Smart Interactive Digital Whiteboard 75"</td> <td>7</td> </tr> <tr> <td>4</td> <td>Teacher's Desk</td> <td>7</td> </tr> <tr> <td>5</td> <td>Student Desk Chair</td> <td>280</td> </tr> <tr> <td>6</td> <td>Office Table</td> <td>10</td> </tr> <tr> <td>7</td> <td>Swivel Chair</td> <td>10</td> </tr> <tr> <td colspan="3">Note: Detailed Technical Specifications for the above items are in Section VI. Specifications</td> </tr> </table> <p>NOTE: The Contractor shall not exceed fifty (50%) for the subcontracted portion of the contract.</p> <p>ADDITIONAL NOTE: The Bill of Quantities to be submitted by the General Contractor must include the BOQ of the portion to be subcontracted.</p>	3	Smart Interactive Digital Whiteboard 75"	7	4	Teacher's Desk	7	5	Student Desk Chair	280	6	Office Table	10	7	Swivel Chair	10	Note: Detailed Technical Specifications for the above items are in Section VI. Specifications														
3	Smart Interactive Digital Whiteboard 75"	7																													
4	Teacher's Desk	7																													
5	Student Desk Chair	280																													
6	Office Table	10																													
7	Swivel Chair	10																													
Note: Detailed Technical Specifications for the above items are in Section VI. Specifications																															
8.3	<p>The eligibility criteria that subcontractors must comply with including the corresponding documentary requirements are as follows:</p> <table border="1"> <thead> <tr> <th>No.</th> <th>Documentary Requirements</th> <th>✓ / ✗</th> </tr> </thead> <tbody> <tr> <td>i)</td> <td>PhilGEPS Certificate of Registration (Platinum Membership);</td> <td></td> </tr> <tr> <td>ii)</td> <td>Statement of SLCC;</td> <td></td> </tr> <tr> <td>iii)</td> <td>NFCC Computation or committed Line of Credit (LoC);</td> <td></td> </tr> <tr> <td>iv)</td> <td>Statement of all its ongoing government and private contracts, including contracts awarded but not yet started, if any, whether similar or not similar in nature and complexity to the contract to be bid;</td> <td></td> </tr> <tr> <td>v)</td> <td>[if applicable] JVA) or in the absence of a JVA, duly notarized statements from all potential JV partners stating that they will enter into and abide by the provisions of the JVA in the event that the bid is successful;</td> <td></td> </tr> <tr> <td>vi)</td> <td>Bid Security in the prescribed form and amount in accordance with ITB Clause 16, and validity period under ITB Clause 15;</td> <td></td> </tr> <tr> <td>vii)</td> <td>Technical Specifications, which may include production or delivery schedule, manpower requirements, or after-sales service or parts, if applicable;</td> <td></td> </tr> <tr> <td>viii)</td> <td>Omnibus Sworn Statement; and</td> <td></td> </tr> <tr> <td>ix)</td> <td>For foreign Bidders claiming eligibility by reason of their country's extension of reciprocal rights to Filipinos, a certification from the relevant government office of their country stating that Filipinos are allowed to participate in their government procurement activities for the same item or product.</td> <td></td> </tr> </tbody> </table>	No.	Documentary Requirements	✓ / ✗	i)	PhilGEPS Certificate of Registration (Platinum Membership);		ii)	Statement of SLCC;		iii)	NFCC Computation or committed Line of Credit (LoC);		iv)	Statement of all its ongoing government and private contracts, including contracts awarded but not yet started, if any, whether similar or not similar in nature and complexity to the contract to be bid;		v)	[if applicable] JVA) or in the absence of a JVA, duly notarized statements from all potential JV partners stating that they will enter into and abide by the provisions of the JVA in the event that the bid is successful;		vi)	Bid Security in the prescribed form and amount in accordance with ITB Clause 16, and validity period under ITB Clause 15;		vii)	Technical Specifications, which may include production or delivery schedule, manpower requirements, or after-sales service or parts, if applicable;		viii)	Omnibus Sworn Statement; and		ix)	For foreign Bidders claiming eligibility by reason of their country's extension of reciprocal rights to Filipinos, a certification from the relevant government office of their country stating that Filipinos are allowed to participate in their government procurement activities for the same item or product.	
No.	Documentary Requirements	✓ / ✗																													
i)	PhilGEPS Certificate of Registration (Platinum Membership);																														
ii)	Statement of SLCC;																														
iii)	NFCC Computation or committed Line of Credit (LoC);																														
iv)	Statement of all its ongoing government and private contracts, including contracts awarded but not yet started, if any, whether similar or not similar in nature and complexity to the contract to be bid;																														
v)	[if applicable] JVA) or in the absence of a JVA, duly notarized statements from all potential JV partners stating that they will enter into and abide by the provisions of the JVA in the event that the bid is successful;																														
vi)	Bid Security in the prescribed form and amount in accordance with ITB Clause 16, and validity period under ITB Clause 15;																														
vii)	Technical Specifications, which may include production or delivery schedule, manpower requirements, or after-sales service or parts, if applicable;																														
viii)	Omnibus Sworn Statement; and																														
ix)	For foreign Bidders claiming eligibility by reason of their country's extension of reciprocal rights to Filipinos, a certification from the relevant government office of their country stating that Filipinos are allowed to participate in their government procurement activities for the same item or product.																														
8.4	<p>The eligibility documents of the subcontractor shall be submitted together with the eligibility documents of the General Contractor and shall form part of the General Contractor's bid submission. Such documents must be enclosed within the same envelopes as those of the General Contractor.</p>																														
9.1	<p>The Procuring Entity will hold a pre-bid conference for this Project on 20 April 2026 @ 09:00am at Gladys F. Rosales Hall, TESDA Regional Office II, Carig Norte, Tuguegarao City, Cagayan and/or through video conferencing</p>																														

	via Zoom platform through this link: <u>https://us02web.zoom.us/j/86947447494?pwd=BbkjZeKiDxg3BCUDHcFWgNR8zpJg5L.1</u> , Zoom Meeting ID: 869 4744 7494 Passcode: tesdar02																								
10.1	The Procuring Entity's address is: TESDA Regional Office II, Carig Norte, Tuguegarao City, Cagayan MS. IMELDA V. GERVACIO Chief Administrative Officer (RBAC Secretariat Head) Contact Number: 09173117263 Email: <u>region2.supplysectiontesda@tesda.gov.ph</u>																								
12.1(h)(ii)	The minimum work experience requirements for key personnel are the following: <table border="1"> <thead> <tr> <th><u>Key Personnel</u></th> <th><u>General Experience</u></th> <th><u>Relevant Experience</u></th> </tr> </thead> <tbody> <tr> <td>Project Engineer</td> <td>Building</td> <td>5 years</td> </tr> <tr> <td>Materials Engineer I</td> <td>General Construction</td> <td>5 years</td> </tr> <tr> <td>Construction Foreman (Holder of NC II)</td> <td>Building</td> <td>5 years</td> </tr> <tr> <td>Scaffolder (Holder of NC II)</td> <td>Building</td> <td>5 years</td> </tr> <tr> <td>Skilled Workers</td> <td>Building</td> <td>5 years</td> </tr> <tr> <td>Construction Safety Officer</td> <td>With Certificate of Training accredited by DOLE</td> <td>With Certificate of Training accredited by DOLE</td> </tr> <tr> <td>First Aider</td> <td>With Certificate of Training issued by Red Cross</td> <td>With Certificate of Training issued by Red Cross</td> </tr> </tbody> </table>	<u>Key Personnel</u>	<u>General Experience</u>	<u>Relevant Experience</u>	Project Engineer	Building	5 years	Materials Engineer I	General Construction	5 years	Construction Foreman (Holder of NC II)	Building	5 years	Scaffolder (Holder of NC II)	Building	5 years	Skilled Workers	Building	5 years	Construction Safety Officer	With Certificate of Training accredited by DOLE	With Certificate of Training accredited by DOLE	First Aider	With Certificate of Training issued by Red Cross	With Certificate of Training issued by Red Cross
<u>Key Personnel</u>	<u>General Experience</u>	<u>Relevant Experience</u>																							
Project Engineer	Building	5 years																							
Materials Engineer I	General Construction	5 years																							
Construction Foreman (Holder of NC II)	Building	5 years																							
Scaffolder (Holder of NC II)	Building	5 years																							
Skilled Workers	Building	5 years																							
Construction Safety Officer	With Certificate of Training accredited by DOLE	With Certificate of Training accredited by DOLE																							
First Aider	With Certificate of Training issued by Red Cross	With Certificate of Training issued by Red Cross																							
12.1(h)(iii)	The minimum major equipment requirements are the following: <table border="1"> <thead> <tr> <th><u>Equipment</u></th> <th><u>Capacity</u></th> <th><u>Number of Units</u></th> </tr> </thead> <tbody> <tr> <td>Backhoe PC 120</td> <td>0.38 – 0.83 cu.m</td> <td>1</td> </tr> <tr> <td>Dump Truck</td> <td>10 – 14 cu.m</td> <td>1</td> </tr> <tr> <td>Transit Mixer</td> <td>4 – 10 cu.m</td> <td>1</td> </tr> <tr> <td>Bagger Mixer</td> <td>1 bagger</td> <td>1</td> </tr> <tr> <td>Concrete Vibrator</td> <td>5.5 hP</td> <td>1</td> </tr> <tr> <td>Welding Machine</td> <td>200 Amp</td> <td>2</td> </tr> </tbody> </table>	<u>Equipment</u>	<u>Capacity</u>	<u>Number of Units</u>	Backhoe PC 120	0.38 – 0.83 cu.m	1	Dump Truck	10 – 14 cu.m	1	Transit Mixer	4 – 10 cu.m	1	Bagger Mixer	1 bagger	1	Concrete Vibrator	5.5 hP	1	Welding Machine	200 Amp	2			
<u>Equipment</u>	<u>Capacity</u>	<u>Number of Units</u>																							
Backhoe PC 120	0.38 – 0.83 cu.m	1																							
Dump Truck	10 – 14 cu.m	1																							
Transit Mixer	4 – 10 cu.m	1																							
Bagger Mixer	1 bagger	1																							
Concrete Vibrator	5.5 hP	1																							
Welding Machine	200 Amp	2																							

	Angle Grinder	5500 rpm	2
	Hand Drill	1000 rpm	2
	Provide proof of ownership or lease agreement for the above-mentioned minimum major equipment requirements.		
12.4	The ABC is Forty Million Ten Thousand Pesos Only (Php40,010,000.00) . Any bid with a financial component exceeding this amount shall not be accepted.		
14.1	The bid prices shall be quoted in Philippine Peso.		
14.3	Not applicable		
15.1	Bids will be valid for <i>120</i> days from bid opening.		
16.1	<p>The Bid Security shall be in the form of a Bid Securing Declaration, and choose one (1) from any of the following:</p> <ol style="list-style-type: none"> 1. The amount of not less than Eight Hundred Thousand Two Hundred Pesos Only (Php800,200.00), if bid security is in cash. 2. The amount of not less than Eight Hundred Thousand Two Hundred Pesos Only (Php800,200.00), if bid security is in cashier's check. 3. The amount of not less than Eight Hundred Thousand Two Hundred Pesos Only (Php800,200.00), if bid security is in manager's check. 4. The amount of not less than Two Million Five Hundred Pesos Only (Php2,000,500.00), if bid security is in bank draft. 5. The amount of not less than Two Million Five Hundred Pesos Only (Php2,000,500.00), if bid security is in guarantee. 6. The amount of not less than Two Million Five Hundred Pesos Only (Php2,000,500.00), if irrevocable Letter of Credit. 7. The amount of not less than Two Million Five Hundred Pesos Only (Php2,000,500.00), if Surety Bond. 		
16.2	The Bid Security shall be valid until <i>01 September 2026</i> .		
16.3	<p><i>In case of extension of bid validity and bid security validity period,</i></p> <p>Substitution of the bid security form is allowed. Bid Securing Declaration and the following forms may be used:</p> <p>a) Cash or Cashier's or Manager's Check issued by a Bank.</p> <p>b) Bank draft/guarantee or irrevocable Letter of Credit issued by a Bank: Provided, however, that it shall be confirmed or authenticated by a local Bank, if issued by a foreign bank.</p>		

19	The address for submission of bids is <i>RBAC Secretariat Office, Administrative Building, TESDA Regional Office II, Carig Norte, Tuguegarao City, Cagayan.</i> The deadline for submission of bids is <i>04 May 2026 @ 07:45am.</i>
21.5	"No further instructions."
22.1	The date and time of bid opening is <i>04 May 2026 @ 08:00am. Zoom platform through this link: https://us02web.zoom.us/j/81228657098?pwd=QEoAoW1w7AF4bKJreDIr9dZhalRS7.1</i> The place of bid opening is <i>Gladys F. Rosales Hall, TESDA Regional Office II, Carig Norte, Tuguegarao City, Cagayan.</i>
22.2(b)	"Not applicable".
25.3 (b)(i)	<p>The quality component shall be assessed on the basis of criteria with corresponding numerical weights, which may include qualitative, environmental, or social aspects linked to the subject matter of the contract. These may include any or a combination of the following:</p> <ul style="list-style-type: none"> a) Quality and technical merit, including technical competence and a credible track record; b) Aesthetic and functional design and characteristics; c) Approach and methodology; d) Accessibility; e) Tools and equipment; f) Social, environmental, economic, and innovative characteristics; g) Organization, qualification, and experience of employees or staff assigned to perform the contract; h) Ongoing contracts and work commitments; i) After-sales service and technical assistance; j) Delivery conditions, such as delivery period and delivery process; k) Disposal measures; or l) Other relevant criteria in relation to the subject Goods or Infrastructure Projects to be procured.
25.3 (b)(iii)	<p><i>The Criteria for Evaluation will be divided into price and quality proposals as follows:</i></p> <p><i>Price - 40%</i></p> <p><i>Quality - 60%</i></p>

25.3(b)

QUALITY CRITERIA EVALUATION:

Criteria	Sub-Criteria	Means of Verification	Rubrics	Weight (%)
A. Quality and Technical Merit; Technical Competence; Organization & Experience of Key Staff				20%
	Completed Similar Projects*	List of completed projects; Certificates of Completion; Contracts	1 Contract - 2% 2 Contracts - 4% 3 Contracts - 6% more than 3 contracts- 8%	8%
	Performance Ratings*	CPES Ratings; or	No. of Rating must be the same with the submitted contracts Average CPES Rating >96% - 6% Average CPES Rating >89% to 96% - 4% Average CPES Rating >82% to 89% - 2% Average CPES Rating <82% - 1%	6%
		Performance Evaluation Certificate (PEC)	PEC shall be first converted as follows: Outstanding/Excellent Rating-5 Very Satisfactory Rating-4 Satisfactory Rating-3 Poor Rating-2 Then, get the final average rating as follows: Average PEC is 5- 6% Average PEC is >4.5 to 4.99- 4% Average PEC is >4 to 4.49- 2% Average PEC is 3.99 and below- 1%	
	Qualification of Key Personnel*	CVs; PRC Licenses; Employment Certificates; Affidavit of Availability	below minimum requirement- 0% Meet minimum requirements- 6%	6%
B. Social, Economic & Innovative Characteristics with Disposal Measures				15%
	Waste Disposal Measures*	Waste Disposal Plan	Pass/Fail	2%
	Socio-Economic Impact*	Local Hiring Plan in Compliance to RA 6685 (Of the Total Skilled 30%-Skilled within the locality; Of the Total Unskilled 50%-Unskilled within the locality)	Pass/Fail	5%
	Skills Certification	In compliance to DOLE Department Order 13-98, All Skilled Workers: Scaffolding Works (Supported-Type) NC II; Electrical Installation and Maintenance NC II; Heavy Equipment Operation NC II (Backhoe)	100% Certified- 5% 80%-99% Certified- 4% 60%-79% Certified- 3% 40%-59% Certified- 2% below 40% Certified- 1%	5%
	Innovation	Innovation Proposal such as: a) Innovation used to fast-track the implementation of the project; and/or b) Added design to Building without additional cost to the PE; and/or c) Cost-Reduction Measures to Lower Electricity and Water Consumption for the Project.	Presence/Absence	3%
C. Approach and Methodology				10%
	Technical Soundness*	Detailed Methodology Statement	Pass/Fail	4%
	Work Program & Scheduling*	PERT/CPM; Construction Schedule and S-Curve	Pass/Fail	2%
	OSH Compliance*	DOLE Approved Construction Safety and Health Program or Duly Submitted Stamped Received DOLE Construction Safety and Health Program, to follow approved before issuance of NTP	Pass/Fail	2%
	Risk & Quality Control Plan*	Risk Management Plan; QA/QC Plan	Pass/Fail	2%
D. Tools and Equipment				10%
	Availability of Equipment*	List of Equipment; Proof of Ownership (OR/CR) or Lease Agreements; Picture of Equipment	Incomplete- 0% Meet the minimum- 3% Above the minimum- 5%	5%
	Suitability/Capacity*	Equipment Specifications; Capacity Documents	Pass/Fail	5%
E. Ongoing Contracts and Work Commitments				5%
	Submission of Information of All On-going Contracts*	Statement of Ongoing Contracts, NOA, Contracts, NTP For Contract Implementation with delays attach Approved Contact Time Extension If No Ongoing Contracts, submit the required template and indicate "No Ongoing Contracts"	Pass/Fail	2%
	Financial Liquidity (NFCC)*	BIR Stamped Received Latest Audited Financial Statements; NFCC Computation	Pass/Fail	3%
Total Technical Score			60.00%	

	<p>To be eligible to proceed to the next stage of the procurement process, a bidder must obtain a minimum score of forty-five (45) points out of sixty (60) in the Quality Evaluation. Bidders who fail to meet the required minimum score shall be rated as failed in the Quality evaluation and shall not proceed to the subsequent stages, including the financial evaluation and determination of the Most Economically Advantageous Responsive Bid (MEARB).</p> <p>For the PRICE EVALUATION, the computation shall be as follows:</p> $\text{Total Price Score} = \left(\frac{\text{Lowest Calculated Financial Bid}}{\text{Bidder's Financial Bid}} \right) \times 40$																						
25.3 (c)(i)	<i>“Not applicable”</i>																						
25.5 (a)	Partial bid is not allowed. The infrastructure project is packaged in a single lot and the lot shall not be divided into sub-lots for the purpose of bidding, evaluation, and contract award.																						
25.5 (b)	Bid correction is not allowed.																						
25.6	No further instructions.																						
26.1	<p><i>PCAB License of Registration at least Category B</i></p> <p><i>PHILGEPS Certificate of Registration (Platinum Membership)</i></p> <p><i>Latest income and business tax return filed for the preceding Quarter which should not be earlier than two (2) quarters from the date of submission and receipt of bid.</i></p>																						
29.3(f)	<p>List additional contract documents relevant to the Project that may be required by existing laws and/or the Procuring Entity and such documents provided should be legible:</p> <table border="1"> <thead> <tr> <th>No</th> <th>Documentary Requirements</th> </tr> </thead> <tbody> <tr> <td>1</td> <td>List of Completed Similar Project/s</td> </tr> <tr> <td>2</td> <td>Certificates of Completion of Listed Completed Similar Project/s</td> </tr> <tr> <td>3</td> <td>Contracts of the Listed Completed Similar Project/s</td> </tr> <tr> <td>4</td> <td>CPES Ratings or Performance Evaluation Certificate of Listed Completed Similar Project/s</td> </tr> <tr> <td>5</td> <td>Organizational Chart</td> </tr> <tr> <td>6</td> <td>Curriculum Vitae of Key Personnel</td> </tr> <tr> <td>7</td> <td>PRC Licenses of Key Personnel, if applicable</td> </tr> <tr> <td>8</td> <td>Employment Certificates of Key Personnel</td> </tr> <tr> <td>9</td> <td>Affidavit of Availability of Key Personnel</td> </tr> <tr> <td>10</td> <td>Waste Disposal Plan</td> </tr> </tbody> </table>	No	Documentary Requirements	1	List of Completed Similar Project/s	2	Certificates of Completion of Listed Completed Similar Project/s	3	Contracts of the Listed Completed Similar Project/s	4	CPES Ratings or Performance Evaluation Certificate of Listed Completed Similar Project/s	5	Organizational Chart	6	Curriculum Vitae of Key Personnel	7	PRC Licenses of Key Personnel, if applicable	8	Employment Certificates of Key Personnel	9	Affidavit of Availability of Key Personnel	10	Waste Disposal Plan
No	Documentary Requirements																						
1	List of Completed Similar Project/s																						
2	Certificates of Completion of Listed Completed Similar Project/s																						
3	Contracts of the Listed Completed Similar Project/s																						
4	CPES Ratings or Performance Evaluation Certificate of Listed Completed Similar Project/s																						
5	Organizational Chart																						
6	Curriculum Vitae of Key Personnel																						
7	PRC Licenses of Key Personnel, if applicable																						
8	Employment Certificates of Key Personnel																						
9	Affidavit of Availability of Key Personnel																						
10	Waste Disposal Plan																						

	11	Local Hiring Plan in Compliance to RA 6685 (Of the Total Skilled 30%-Skilled within the locality; Of the Total Unskilled 50%-Unskilled within the locality)
	12	National Certificate Requirement (use template in the Section IX. Philippine Bidding Documents Related Forms Annex A List of Skilled/Unskilled Workers Assigned for the Project)
	13	Certified True Copies of National Certificate
	14	Manpower Schedule
	15	Innovation Proposal
	16	Detailed Methodology Statement (Construction Methods)
	17	PERT/CPM
	18	Construction Schedule and S-curve
	19	DOLE Approved Construction Safety and Health Program or DOLE Stamped Received Construction Safety and Health Program
	20	Risk Management Plan
	21	QA/QC Plan
	22	List of Equipment
	23	Proof of Ownership (OR/CR) or Lease Agreements of the Listed Equipment
	24	Pictures of the Listed Equipment
	25	Equipment Utilization Schedule
	26	Equipment Specifications of the Listed Equipment
	27	Statement of Ongoing Contracts, if No Ongoing Contracts, submit the required template and indicate "No Ongoing Contracts"
	28	NOA of Ongoing Contracts, if with Ongoing Contracts
	29	Contacts of Ongoing Contracts, if with Ongoing Contracts
	30	NTP of Ongoing Contracts
	31	For Contract Implementation with delays attach Approved Contract Time Extension
	32	BIR Stamped Received Latest Audited Financial Statements
	33	NFCC Computation
30.2	"Not applicable"	
30.3	<p>The Performance Security shall be in the form:</p> <p>The amount of not less than 30% of the contract price if performance security is Surety Bond.</p>	

Section IV. General Conditions of Contract

Notes on the General Conditions of Contract

The GCC in Section IV, read in conjunction with the SCC in Section V and other documents listed therein, should be a complete document expressing all the rights and obligations of the parties.

The GCC herein shall not be altered. Any changes and complementary information which may be needed shall be introduced only through the SCC in Section V.

TABLE OF CONTENTS

1. General Terms.....	577
2. Interpretation.....	577
3. Governing Language and Law	588
4. Communications.....	588
5. Possession of Site.....	588
6. The Contractor's Obligations	59
7. Subcontracting.....	59
8. Advance Payment.....	61
9. Progress Payments	61
10. Payment Documents	62
11. Retention	63
12. Performance Security	63
13. Detailed Engineering and Site Investigation Reports	64
14. Licenses and Permits.....	65
15. Contractor's Risk and Warranty Security	65
16. Procuring Entity's Risk	68
17. Insurance	68
18. Liquidated Damages.....	69
19. Settlement of Disputes.....	70
20. Liability of the Contractor.....	70
21. Termination for Breach of Contract	70
22. Termination Due to Force Majeure	71
23. Termination by Contractor	72
24. Termination for Convenience.....	72
25. Termination for Unlawful Acts	73
26. Termination for Other Causes.....	73
27. Procedures for Termination of Contracts.....	74
28. Approval of Drawings and Temporary Works by the Procuring Entity	75
29. Acceleration and Delays Ordered by the Procuring Entity	76
30. Contractor's Right to Claim.....	76
31. Dayworks	76
32. Early Warning.....	76

33. Program of Work.....	76
34. Management Conferences.....	77
35. Bill of Quantities	77
36. Instructions, Inspections and Audits	78
37. Identifying Defects.....	78
38. Correction of Defects	78
39. Uncorrected Defects.....	78
40. Variation Orders.....	79
41. Contract Completion	80
42. Suspension of Work.....	81
43. Payment on Termination.....	81
44. Extension of Contract Time.....	82
45. Price Escalation	83
46. Completion	83
47. Taking Over	83
48. Operating and Maintenance Manuals.....	83

1) General Terms

In this Contract, the following terms shall be interpreted as indicated:

- 1.1 The **Intended Completion Date** refers to the date specified in the **SCC** when the Contractor is expected to have completed the Works. The intended Completion Date may be revised only by the Procuring Entity by issuing an extension of time or an acceleration order.
- 1.2 The **Procuring Entity** is the party who employs the Contractor to carry out the Works stated in the **SCC**.
- 1.3 The **Site** is the place provided by the Procuring Entity where the Works shall be executed and any other place or places which may be designated in the **SCC**, or notified to the Contractor by the Procuring Entity as forming part of the Site.
- 1.4 The **Start Date**, as specified in the **SCC**, is the date when the Contractor is obliged to commence execution of the Works. It does not necessarily coincide with any of the Site Possession Dates.
- 1.5 **Work(s)** refer to the Permanent Works and Temporary Works to be executed by the Contractor in accordance with this Contract, including (i) the furnishing of all labor, materials, equipment and others incidental, necessary or convenient to the complete execution of the Works; (ii) the passing of any tests before acceptance by the Procuring Entity; (iii) and the carrying out of all duties and obligations of the Contractor imposed by this Contract as described in the **SCC**. In line with this, Temporary Works are works designed, constructed, and installed by the Contractor that are needed for construction or installation of the Permanent Works, which are subsequently removed.

2) Interpretation

- 2.1 In interpreting the Conditions of Contract, singular also means plural, male also means female or neuter, and the other way around. Headings have no significance. Words have their normal meaning under the language of this Contract unless specifically defined. The Procuring Entity will provide instructions clarifying queries about the Conditions of Contract.
- 2.2 If sectional completion is specified in the **SCC**, references in the Conditions of Contract to the Works, the Completion Date, and the Intended Completion Date apply to any Section of the Works (other than references to the Completion Date and Intended Completion Date for the whole of the Works).
- 2.3 The documents forming this Contract shall be interpreted in the following order of priority:
 - a) Contract Agreement;
 - b) Bid Data Sheet;
 - c) Instructions to Bidders;
 - d) Addenda to the Bidding Documents;

- e) Special Conditions of Contract;
- f) General Conditions of Contract;
- g) Specifications;
- h) Bill of Quantities; and
- i) Drawings.

3) **Governing Language and Law**

- 3.1 This Contract shall be interpreted in accordance with the laws of the Republic of the Philippines.
- 3.2 This Contract has been executed in the English language, which shall be the binding and controlling language for all matters relating to the meaning or interpretation of this Contract. All correspondence and other documents pertaining to this Contract which are exchanged by the parties shall be written in English.

4) **Communications**

Communications between parties that are referred to in the Conditions shall be effective only if made in writing. A notice shall be effective only when it is received by the concerned party.

5) **Possession of Site**

- 5.1 On the date specified in the **SCC**, the Procuring Entity shall grant the Contractor possession of so much of the Site as may be required to enable it to proceed with the execution of the Works. If the Contractor suffers delay or incurs cost from failure on the part of the Procuring Entity to give possession in accordance with the terms of this clause, the Procuring Entity shall give the Contractor a Contract Time Extension and certify such sum as fair to cover the cost incurred, which sum shall be paid by Procuring Entity.
- 5.2 If possession of a portion is not given by the date stated in the **SCC** Clause 1.3, the Procuring Entity will be deemed to have delayed the start of the relevant activities. The resulting adjustments in contract time to address such delay shall be in accordance with **GCC** Clause 44.
- 5.3 The Contractor shall bear all costs and charges for special or temporary right-of-way required by it in connection with access to the Site. The Contractor shall also provide at its own cost any additional facilities outside the Site required by it for purposes of the Works.
- 5.4 The Contractor shall allow the Procuring Entity and any person authorized by the Procuring Entity access to the Site and to any place where work in connection with this Contract is being carried out or is intended to be carried out.

6) The Contractor's Obligations

- 6.1 The Contractor shall carry out the Works properly and in accordance with this Contract. The Contractor shall provide all supervision, labor, Materials, Plant and Contractor's Equipment, which may be required. All Materials and Plant on Site shall be deemed to be the property of the Procuring Entity.
- 6.2 The Contractor shall commence execution of the Works on the Start Date and shall carry out the Works in accordance with the Program of Work submitted by the Contractor, as updated with the approval of the Procuring Entity, and complete them by the Intended Completion Date.
- 6.3 The Contractor shall be responsible for the safety of all activities on the Site.
- 6.4 The Contractor shall carry out all instructions of the Procuring Entity that comply with the applicable laws where the Site is located.
- 6.5 The Contractor shall employ the key personnel named in the Schedule of Key Personnel, as referred to in the **SCC**, to carry out the supervision of the Works. The Procuring Entity will approve any proposed replacement of key personnel only if their relevant qualifications and abilities are equal to or better than those of the personnel listed in the Schedule.
- 6.6 If the Procuring Entity asks the Contractor to remove a member of the Contractor's staff or work force, for justifiable cause, the Contractor shall ensure that the person leaves the Site within seven (7) days and has no further connection with the Work in this Contract.
- 6.7 During Contract implementation, the Contractor and its subcontractors shall abide at all times by all labor laws, including child labor related enactments, and other relevant rules.
- 6.8 The Contractor shall submit to the Procuring Entity for consent the name and particulars of the person authorized to receive instructions on behalf of the Contractor.
- 6.9 The Contractor shall cooperate and share the Site with other contractors, public authorities, utilities, and the Procuring Entity between the dates given in the schedule of other contractors particularly when they shall require access to the Site. The Contractor shall also provide facilities and services for them during this period. The Procuring Entity may modify the schedule of other contractors, and shall notify the Contractor of any such modification thereto.
- 6.10 Should anything of historical or other interest or of significant value be unexpectedly discovered on the Site, it shall be the property of the Procuring Entity. The Contractor shall notify the Procuring Entity of such discoveries and carry out the Procuring Entity's instructions in dealing with them.

7) Subcontracting

- 7.1 Unless otherwise indicated in the **SCC**, the Contractor shall not subcontract portions of the Works beyond the percentage specified in **BDS** Clause 8.1. If subcontracting is allowed, the arrangement, including the timing for submission of the subcontractor's eligibility documents, shall be disclosed.

7.2 For subcontracting arrangements, the following rules shall apply for both locally-funded projects and to projects financed through Official Development Assistance, except those covered by treaty, or international, or executive agreements:

- a) The subcontracted portion of the contract shall be subject to the approval of the HoPE and the following conditions:
 - i) The subcontracted portion shall not exceed fifty percent (50%), or a different percentage on a per project basis as approved by the GPPB. The threshold percentages fixed herein shall be subject to the periodic review and adjustments as may be deemed appropriate by the GPPB; and
 - ii) The subcontracted portion shall be limited to components that are not deemed "significant or material" to the project as determined by the Procuring Entity.
- b) Subcontracting arrangement, if allowed, including the time of submission of the eligibility documents of the subcontractor, shall be disclosed in the Bidding Documents;
- c) Subcontractors must meet the eligibility criteria and shall submit the same eligibility documents as the general contractor.

Failure of a subcontractor to meet the eligibility criteria does not affect the eligibility of the general contractor for the procurement project. In such case, the portion intended to be subcontracted to the ineligible subcontractor shall be assumed by the general contractor;
- d) The general contractor shall remain liable for the subcontractor's actions, defaults, delays, and negligence;
- e) The general contractor and the subcontractor are obliged to comply with the provisions of the contract and shall share liability, jointly and severally, in cases of violation of safety standards or other labor standards insofar as the subcontracted portion is concerned; and
- f) For purposes of post-qualification in accordance with its objective and process under the IRR, the value of the entire completed and accepted Project, including the subcontracted portion, shall be credited as experience of the general contractor. In the case of the subcontractor, the following rules shall apply:
 - i) The subcontractor shall get credit for one hundred percent (100%) of the value of the subcontracted portion of the project performed;
 - ii) Subcontractors shall be eligible to concessional windows of GFIs that treat receivables from the government as loan security; the receivables of subcontractors due from their general contractor shall similarly be accepted as loan security by GFIs; and

- iii) Contract performance monitoring, such as the use of CPES, among others, shall also be mandatorily applied to the work experience of the subcontractors.

8) Advance Payment

- 8.1 The Procuring Entity shall make an advance payment on the Contract Price to the Contractor in an amount not exceeding fifteen percent (15%) of the total contract price to be made in lump sum or, at the most, two installments according to a schedule specified in the **SCC**.
- 8.2 The advance payment shall be made only upon:
 - i) Written request of the contractor which shall form part of the contract document; and
 - ii) Submission of an irrevocable standby Letter of Credit of equivalent value from a bank as confirmed by the Procuring Entity; a bank guarantee; or a surety bond callable upon demand issued by a duly licensed surety or insurance company, at the option of the Procuring Entity.
- 8.3 The advance payment shall be recovered from the Contractor through deductions in amounts equivalent to the percentage of the total contract price that corresponds to the value of the advance payment granted.
- 8.4 Once a month, Contractors may submit documents, such as Monthly Certificates,⁷ to show the progress or partial completion of a project. The Contractor may reduce its standby letter of credit or guarantee instrument by the amounts refunded by the Monthly Certificates, or any equivalent document subject to auditing and accounting rules, in the advance payment.

9) Progress Payments

- 9.1 Once a month, the Contractor may submit a statement of work accomplished (SWA) or progress billing and corresponding request for progress payment for work accomplished. The SWA should show the amounts which the Contractor considers itself to be entitled to up to the end of the month, to cover (i) the cumulative value of the Works it executed to date, based on the items in the Bill of Quantities, and (ii) adjustments made for approved Variation Orders executed. Alternatively, the Procuring Entity may require in the Bidding Documents that the SWA or progress billing and the corresponding request for progress payment may only be submitted upon actual completion of the Infrastructure Project or a specific portion, segment, milestone or phase thereof.

The Procuring Entity or Project Engineer shall check the Contractor's SWA and certify the amount to be paid to the Contractor as progress payment. Materials and equipment delivered onsite but not yet incorporated in the Works shall not be included for payment, except as otherwise stipulated in the **SCC**.

⁷ Commission on Audit (COA) Circular 2012-001.

- 9.2 The Procuring Entity shall deduct the following from the certified gross amounts to be paid to the Contractor as progress payment:
- a) Cumulative value of the work previously certified and paid for.
 - b) Portion of the advance payment to be recouped.
 - c) Retention money in accordance with the conditions of the contract.
 - d) Amount to cover third-party liabilities.
 - e) Amount to cover uncorrected discovered defects in the Works.
- 9.3 Payments shall be adjusted by deducting therefrom the amounts for advance payments and retention. The Procuring Entity shall pay the Contractor the amounts certified by the Procuring Entity within twenty-eight (28) days from the date each certificate was issued. No payment of interest for delayed payments and adjustments shall be made by the Procuring Entity.
- 9.4 The first progress payment may be paid by the Procuring Entity to the Contractor, as indicated in the **SCC**; Provided, That at least a percentage of the Works has been accomplished as certified by the Procuring Entity and as indicated in the **SCC**.
- 9.5 Items of the Works for which a price of "0" (zero) has been entered will not be paid for by the Procuring Entity and shall be deemed covered by other rates and prices in the Contract.

10) Payment Documents

- 10.1 Subject to existing accounting and auditing rules and regulations,⁸ the Contractor shall submit to the Procuring Entity monthly statements of the estimated value of the work executed less the cumulative amount certified previously.
- 10.2 The Procuring Entity shall check the Contractor's monthly statement and certify the amount to be paid to the Contractor.
- 10.3 The value of Work executed shall:
- a) be determined by the Procuring Entity;
 - b) comprise the value of the quantities of the items in the Bill of Quantities completed; and
 - c) include the valuations of approved variations.
- 10.4 The Procuring Entity may exclude any item certified in a previous certificate or reduce the proportion of any item previously certified in any certificate in the light of later information.

⁸ COA Circular No. 2012-001.

11) Retention

- 11.1 The Procuring Entity shall retain from each payment due to the Contractor an amount equal to a percentage thereof using the rate as specified in GCC Clause 11.2. The said amount will serve to guarantee indemnity for uncorrected discovered defects and third-party liabilities arising from this Contract. This retention money shall be utilized if the contractor fails to repair the discovered defects. Should the retention money be insufficient, the PE may forfeit the performance security, which may ultimately lead to the termination of the contract.⁹
- 11.2 Progress payments are subject to retention of ten percent (10%) referred to as the retention money. Such retention shall be based on the total amount due to the Contractor prior to any deduction and shall be retained from every progress payment until fifty percent (50%) of the value of the Works, as determined by the Procuring Entity, are completed.
- If, after fifty percent (50%) completion, the work is satisfactorily done and on schedule, no additional retention shall be made; otherwise, the ten percent (10%) retention shall be imposed, which may be decreased to 5 percent (5%) by the Procuring Entity based on justifiable causes.¹⁰
- 11.3 The total retention money shall be due for release upon final acceptance of the Works. The Contractor may, however, request the substitution of the retention money for each progress billing with irrevocable standby Letters of Credit from a bank, bank guarantees or surety bonds callable on demand, of amounts equivalent to the retention money substituted for and acceptable to Government; Provided, That the project is on schedule and is satisfactorily undertaken. Otherwise, the ten (10%) percent retention shall be made. Said irrevocable standby letters of credit, bank guarantees and/or surety bonds, to be posted in favor of the Government shall be valid for a duration to be determined by the concerned implementing office/agency or Procuring Entity and will answer for the purpose for which the ten (10%) percent retention is intended, *i.e.*, to cover uncorrected discovered defects and third party liabilities.
- 11.4 On completion of the whole Works, the Contractor may substitute retention money with an “on demand” Bank guarantee in a form acceptable to the Procuring Entity.

12) Performance Security

- 12.1 Within ten (10) calendar days from receipt of the Notice of Award from the Procuring Entity, but in no case later than the signing of the contract by both parties, the winning Contractor shall furnish the performance security in any of the forms prescribed in **ITB** Clause 30 in relation to **BDS** Clause 30.2 and 30.3.

⁹ Supreme Court rulings (e.g. New Bian Yek Commercial, Inc. vs. Office of the Ombudsman, et. al., GR No. 169338[2009], and Tondo Medical Center vs. Rante, G.R. No. 230645 [2019] have affirmed this purpose, stating that retention money is a form of security to ensure the satisfactory completion of works and to cover any defects or third-party claims that may arise after project completion.

¹⁰ Section 71.2.8 of the IRR.

- 12.2 The performance security posted in favor of the Procuring Entity shall be forfeited in the event it is established that the Contractor is in default in any of its obligations under the contract.
- 12.3 The performance security shall remain valid until issuance by the Procuring Entity of the Certificate of Final Acceptance. In case the performance security issued is valid for a specific period shorter than the term of the contract, including the defects liability period, the same shall be renewed or extended as often as necessary and immediately submitted to the Procuring Entity. In case of approved contract time extensions, the Contractor shall cause the extension of the validity of the performance security to cover the said extensions.
- 12.4 The performance security may be released by the Procuring Entity after the issuance of the Certificate of Final Acceptance; Provided, That the Procuring Entity has no claims filed against the performance security.
- 12.5 The Contractor shall post an additional performance security following the amount and form specified in **ITB Clause 30** to cover any cumulative increase of more than ten percent (10%) over the original value of the contract as a result of change orders, extra work orders and supplemental agreements, as the case may be.
- 12.6 In case of a reduction in the contract value or for partially completed Works under the contract which are usable and accepted by the Procuring Entity the use of which, in the judgment of the implementing agency or the Procuring Entity, will not affect the structural integrity of the entire project, the Procuring Entity shall allow a proportional reduction in the original performance security, provided that any such reduction is more than ten percent (10%) and that the aggregate of such reductions is not more than fifty percent (50%) of the original performance security.
- 12.7 Unless otherwise indicated in the **SCC**, the Contractor, by entering into the Contract with the Procuring Entity, acknowledges the right of the Procuring Entity to institute action pursuant to Act No. 3688¹¹ against any subcontractor be they an individual, firm, partnership, corporation, or association supplying the Contractor with labor, materials and/or equipment for the performance of this Contract.

13) Detailed Engineering and Site Investigation Reports

- 13.1 The Contractor, in preparing the Bid, shall rely on all Site Investigation Reports referred to in the **SCC** supplemented by any information obtained by the Contractor.
- 13.2 Detailed engineering shall proceed only on the basis of the feasibility or preliminary engineering study made which establishes the technical viability of the project and conformance to land use and zoning guidelines prescribed by existing laws. The findings contained in the feasibility study, if undertaken for the project, shall be examined. If, in the course of this exercise, it is found that amendments would be desirable in the design standards of principal features, as proposed, specific recommendations for such changes shall be supported

¹¹ Also known as "An Act for the Protection of Persons Furnishing Material and Labor for the Construction Of Public Works".

by detailed justifications, including their effects on the cost, and the economic justifications, if necessary.

13.3 A schedule of detailed engineering activities shall include the following:

- a) Survey;
- b) Site Investigation;
- c) Soils and Foundation Investigation;
- d) Construction Materials Investigation;
- e) Preparation of Design Plans;
- f) Preparation of Technical Specifications;
- g) Preparation of Quantity and Cost Estimates;
- h) Preparation of Scope of Work;
- i) Preparation of Proposed Construction Schedule (and estimated Cash Flow for projects with Schedule over six (6) months);
- j) Preparation of Site or Right-of-Way Plans including Schedule of Acquisition;
- k) Preparation of Utility Relocation Plan;
- l) Preparation and Submission of Design Report;
- m) Environmental Impact Statement for critical project, as defined by the Department of Environment and Natural Resources;
- n) Preparation of minimum requirements for a Construction Safety and Health Program for the project being considered;
- o) Value Engineering Studies; and
- p) Preparation of report on asset climate hazards, risk assessment, disaster response strategies, and readiness planning.

13.4 Work under detailed architectural and engineering design shall include, among others, the items stated in Section 8.3 of the IRR.

14) Licenses and Permits

The Procuring Entity may, if requested by the Contractor, assist him in applying for permits, licenses or approvals, which are required for the Works.

15) Contractor's Risk and Warranty Security

15.1 From the time project construction commenced up to final acceptance, the Contractor shall assume full responsibility for any damage or destruction of the works, except those occasioned by force majeure; and the safety, protection, security, and convenience of its personnel, third parties, and the public at large,

as well as the works, equipment, installation and the like to be affected by its construction work.

- 15.2 The defects liability period for infrastructure projects shall be one (1) year from project completion up to final acceptance by the Procuring Entity. During this period, the Contractor shall undertake the repair works, at its own expense, of any damage to the Works on account of the use of materials of inferior quality, defects in the construction, or due to any violation of the terms of the contract, within ninety (90) calendar days from the time the HoPE has issued an order to undertake repair. In case of failure or refusal to comply with this mandate, the Procuring Entity shall undertake such repair works and shall be entitled to full reimbursement of expenses incurred therein upon demand.
- 15.3 The defects liability period shall be covered by the performance security of the Contractor required in Section 68 of the IRR, which shall guarantee that the Contractor performs its responsibilities stated in **GCC** Clause 15.1 Unless otherwise indicated in the **SCC**, in case the Contractor fails to comply with the preceding paragraph, the Procuring Entity shall forfeit its performance security, subject its properties to attachment or garnishment proceedings, and may impose the appropriate penalty under Sections 99, 100, and 101 of the IRR. All payables of the GoP in its favor shall be offset to recover the costs.
- 15.4 The following persons shall be held responsible for “Structural Defects,” i.e., major faults or flaws or deficiencies in one or more key structural elements of the project which may lead to structural failure of the completed elements or structure, or “Structural Failures,” i.e., where one or more key structural elements in an infrastructure facility fails or collapses, thereby rendering the facility or part thereof incapable of withstanding the design loads, and/or endangering the safety of the users or the general public:
 - a) Contractor – Where Structural Defects or Failures arise due to faults attributable to improper construction, use of inferior quality/substandard materials, and any violation of the contract plans and specifications, the Contractor shall be held liable;
 - b) Consultants – Where Structural Defects or Failures arise due to faulty and/or inadequate design and specifications as well as construction supervision, then the consultant who prepared the design or undertook construction supervision for the project shall be held liable;
 - c) Procuring Entity’s Representatives or Project Manager or Construction Managers and Supervisors – The project owner’s representative, project manager, construction manager, and supervisor shall be held liable in cases where the Structural Defects or Failures are due to their willful intervention in altering the designs and other specifications; negligence or omission in not approving or acting on proposed changes to noted defects or deficiencies in the design and/or specifications and the use of substandard construction materials in the project;
 - d) Third Parties - Third Parties shall be held liable in cases where Structural Defects or Failures are caused by work undertaken by them such as leaking pipes, diggings or excavations, underground cables and electrical wires, underground tunnel, mining shaft and the like, in which case the applicable warranty to such structure should be levied to third parties for their construction or restoration works; and

- e) Users - In cases where Structural Defects or Failures are due to abuse or misuse by the End-User or Implementing Unit of the constructed facility and/or non-compliance by a user with the technical design limits and/or intended purpose of the same, then the user concerned shall be held liable.

15.5 The warranty against Structural Defects or Failures, except those occasioned by force majeure, shall cover the period specified in the **SCC** reckoned from the date of issuance of the Certificate of Final Acceptance by the Procuring Entity. On the other hand, such warranty shall likewise be applied against non-structural defects for instances that pertain to faults or deficiencies in non-load bearing components or finishes of the Project, such as minor cracks, leaks, or defects in workmanship or materials, which do not affect the stability or safety of the structure but may impact its appearance, functionality, or usability.

15.6 To guarantee that the Contractor shall perform its responsibilities, it shall be required to post a warranty security, which shall be stated in Philippine Peso, in the form chosen by the Procuring Entity in accordance with the following schedule:

Form of Warranty	Amount of Warranty Security Not less than the Percentage (%) of Total Contract Price
(a) Cash or letter of credit issued by bank; Provided, however, that the letter of credit shall be confirmed or authenticated by a local bank, if issued by a foreign bank. For biddings conducted by LGUs, the Letter of Credit may be issued by other banks certified by the BSP as authorized to issue such financial instrument.	Five Percent (5%)
(b) Bank guarantee confirmed by bank. For biddings conducted by LGUs, the bank draft/guarantee may be issued by other banks certified by the BSP as authorized to issue such financial instrument.	Ten Percent (10%)
(c) Surety bond callable upon demand issued by GSIS or any surety or insurance company duly certified by the Insurance Commission	Thirty Percent (30%)

15.7 The warranty security shall be stated in Philippine Peso and shall remain effective within one (1) year from the date of issuance of the Certificate of Final Acceptance by the Procuring Entity, and returned only after the lapse of the said one (1) year period. This one (1) year period shall cover both structural and non-structural defects or failures; Provided, That in cases of structural defects or failures, warranties beyond the one (1) year period shall be subject to applicable laws, rules, and regulations such as the New Civil Code of the Philippines.

15.8 In case of structural/non-structural defects or failure occurring during the applicable warranty period provided in **GCC** Clause 15.5, the Procuring Entity shall undertake the necessary restoration or reconstruction works and shall be entitled to full reimbursement by the parties found to be liable for expenses incurred therein upon demand, without prejudice to the imposition of administrative sanctions as prescribed by RA No. 12009 and without prejudice to the imposition of civil and criminal sanctions as provided under applicable laws against the responsible persons as well as the forfeiture of the warranty security posted in favor of the Procuring Entity.

16) Procuring Entity's Risk

16.1 From the Start Date until the Certificate of Final Acceptance has been issued, the following are risks of the Procuring Entity:

- a) The risk of personal injury, death, or loss of or damage to property (excluding the Works, Plant, Materials, and Equipment), which are due to:
 - i) any type of use or occupation of the Site authorized by the Procuring Entity after the official acceptance of the Works; or
 - ii) negligence, breach of statutory duty, or interference with any legal right by the Procuring Entity or by any person employed or contracted by it, except the Contractor.
- b) The risk of damage to the Works, Plant, Materials, and Equipment to the extent that it is due to a fault of the Procuring Entity or in the Procuring Entity's design, or due to war or radioactive contamination directly affecting the country where the Works are to be executed.

17) Insurance

17.1 The Contractor shall, under its name and at its own expense, obtain and maintain, for the duration of this Contract, the following insurance coverage:

- a) Contractor's All Risk Insurance, with an exception for Simple Infrastructure Projects, as applicable;
- b) Transportation to the project Site of Equipment, Machinery, and Supplies owned by the Contractor;
- c) Personal injury or death of Contractor's employees; and
- d) Comprehensive insurance for third party liability to Contractor's direct or indirect act or omission causing damage to third persons.

17.2 The Contractor shall provide evidence to the Procuring Entity that the insurances required under this Contract have been effected and shall, within a reasonable time, provide copies of the insurance policies to the Procuring Entity.

17.3 The Contractor shall notify the insurers of changes in the nature, extent, or program for the execution of the Works and ensure the adequacy of the insurances at all times in accordance with the terms of this Contract and shall

produce to the Procuring Entity the insurance policies in force including the receipts for payment of the current premiums.

The above insurance policies shall be obtained from any reputable insurance company approved by the Procuring Entity.

- 17.4 If the Contractor fails to obtain and keep in force the insurances referred to herein or any other insurance required to be obtained under the terms of this Contract, the Procuring Entity may obtain and keep in force any such insurances and pay such premiums as may be necessary for the purpose. From time to time, the Procuring Entity may deduct the amount it shall pay for said premiums including twenty five percent (25%) therein from any monies due, or which may become due, to the Contractor, without prejudice to the Procuring Entity exercising its right to impose other sanctions against the Contractor pursuant to the provisions of this Contract.
- 17.5 In the event the Contractor fails to observe the above safeguards, the Procuring Entity may, at the Contractor's expense, take whatever measure is deemed necessary for its protection and that of the Contractor's personnel and third parties, and/or order the interruption of dangerous Works. In addition, the Procuring Entity may refuse to make the payments under **GCC** Clause 9 until the Contractor complies with this Clause.
- 17.6 The Contractor shall immediately replace the insurance policy obtained as required in this Contract, without need of the Procuring Entity's demand, with a new policy issued by a new insurance company acceptable to the Procuring Entity for any of the following grounds:
- a) The issuer of the insurance policy to be replaced has:
 - i) become bankrupt;
 - ii) been placed under receivership or under a management committee;
 - iii) been sued for suspension of payment;
 - iv) been suspended by the Insurance Commission and its license to engage in business or its authority to issue insurance policies has been cancelled; or
 - v) Where reasonable grounds exist that the insurer may not be able, fully and promptly, to fulfill its obligation under the insurance policy.

18) Liquidated Damages

- 18.1 When the Contractor fails to satisfactorily complete the Works under the contract within the specified contract duration, inclusive of duly granted time extensions, if any, the Contractor shall be liable for liquidated damages in an amount equal to at least one-tenth (1/10) of one percent (1%) of the cost of the unperformed portion of the Works for every day of delay.
- 18.2 In computing liquidated damages, the Procuring Entity shall determine the usability of the project. A project or a portion thereof may be deemed usable

when it starts to provide the desired benefits as certified by the End-User or Implementing Unit and approved by the HoPE.

- 18.3 To be entitled to liquidated damages, the Procuring Entity does not have to prove that it has incurred actual damages. Such amount shall be deducted from any money due, or which may become due the Contractor under the contract, collected from the retention money or other securities posted by the Contractor, or a combination thereof, whichever is convenient to the Procuring Entity.
- 18.4 In case the total sum of liquidated damages reaches ten percent (10%) of the total contract price, the Procuring Entity may rescind or terminate the contract, without prejudice to other courses of action and remedies available under the circumstances.
- 18.5 If the Intended Completion Date is extended after liquidated damages have been paid, the Procuring Entity shall correct any overpayment of liquidated damages by the Contractor by adjusting the next payment schedule.

19) Settlement of Disputes

- 19.1 Any dispute arising from the implementation of a contract covered by the Act and the IRR shall primarily be resolved and settled amicably by mutual consultation or agreement.
- 19.2 In case of failure to settle the dispute amicably, the parties may mutually agree in writing to resort to other modes of alternative dispute resolution (ADR) to promote efficiency in the procurement process. Accordingly, they are encouraged to select the most expeditious mode of ADR available.

If arbitration is chosen as the ADR method, this shall be incorporated as a provision in the contract and referred to the Arbitrator specified in the **SCC**.
- 19.3 If the dispute remains unresolved after exhausting the remedies provided above, it may be submitted to other forms of ADR, such as mediation, conciliation, early neutral evaluation, mini-trial, or any combination thereof, in accordance with RA No. 9285, otherwise known as the "Alternative Dispute Resolution Act of 2004". However, disputes that are within the competence or jurisdiction of the Construction Industry Arbitration Commission shall be referred to the same for resolution.¹²

20) Liability of the Contractor

Subject to additional provisions, if any, set forth in the **SCC**, the Contractor's liability under this Contract shall be as provided by the laws of the Republic of the Philippines.

21) Termination for Breach of Contract

- 21.1 The Procuring Entity shall terminate the contract for breach thereof when any of the following conditions are present:

¹² Executive Order No. 1008 (Construction Industry Arbitration Law); and Construction Industry Arbitration Commission Revised Rules of Procedure.

- a) Due to the Contractor's fault and while the project is on-going, it has incurred negative slippage of fifteen percent (15%) or more in accordance with Presidential Decree No. 1870, s. 1983;
- b) Due to the Contractor's fault and after the contract time has expired, it has incurred a negative slippage of ten percent (10%) or more in the completion of the work;
- c) The Contractor abandons the contract works, plainly demonstrates an intention not to continue the performance of the Contractor's obligations under the contract, refuses or fails to comply with the Procuring Entity's instructions, or fails to proceed expeditiously and without delay despite a written notice by the Procuring Entity;
- d) When the Contractor, without reasonable excuse, fails to comply with the Notice of Rejection given by the Project Engineer that, after examination therein, the Infrastructure Project is found to be defective or otherwise not in accordance with the Contract, or a Project Engineer's instruction to conduct remedial work, within 30 days after receiving the said notice;
- e) The Contractor does not actually have on the project site the minimum essential equipment listed on the Bid necessary to prosecute the Works in accordance with the approved work plan and equipment deployment schedule as required for the project;
- f) The Contractor does not execute the Works in accordance with the contract or persistently or flagrantly neglects to carry out its obligations under the contract;
- g) The Contractor neglects or refuses to remove materials or to perform a new work that has been rejected as defective or unsuitable;
- h) The Contractor subcontracts any part of the contract works without approval by the Procuring Entity; or
- i) The Contractor becomes bankrupt or insolvent; goes into liquidation, administration, reorganization, winding-up, or dissolution; becomes subject to the appointment of a liquidator, receiver, administrator, manager, or trustee; enters into a composition or arrangement with the Contractor's creditors; or any act is done or any event occurs which is analogous to or has a similar effect to any of these acts or events under applicable laws.

21.2 All materials on the Site, Plant, Works, including Equipment paid under this Contract, including those identified by the Procuring Entity in the **SCC** pursuant to GCC Clause 9.1, shall be deemed to be the property of the Procuring Entity if this Contract is terminated because of the Contractor's breach.

22) Termination Due to Force Majeure

22.1 For purposes of this Contract the terms "*force majeure*" and "fortuitous event" may be used interchangeably. In this regard, a fortuitous event or *force majeure* shall be interpreted to mean an event which could not have been foreseen, or though foreseen, was inevitable. It shall not include ordinary

unfavorable weather conditions, and any other cause the effects of which could have been avoided with the exercise of reasonable diligence by the Contractor.

- 22.2 If this Contract is discontinued by an outbreak of war or by any other similar event entirely outside the control of either the Procuring Entity or the Contractor, the Procuring Entity shall certify that this Contract has been discontinued. The Contractor shall make the Site safe and stop work as quickly as possible after receiving the certificate and shall be paid for all Works carried out before receiving it and for any Work carried out afterwards to which a commitment was made by the Procuring Entity.
- 22.3 If the event continues for a period of eighty-four (84) days, either party may then give notice of termination, which shall take effect twenty-eight (28) days after the giving of the notice.
- 22.4 After termination, the Contractor shall be entitled to payment of the unpaid balance of the value of the Works executed and of the materials and Plant, in relation to GCC Clause 9.1 and 21.2, adjusted by the following:
- (a) any sum to which the Contractor is entitled under **GCC** Clause 30; and
 - (b) any sum to which the Procuring Entity is entitled.
- 22.5 The net balance due shall be paid or repaid within a reasonable time period from the time of the notice of termination.

23) Termination by Contractor

The Contractor may terminate this Contract with the Procuring Entity if the Works are completely stopped for a continuous period of at least sixty (60) calendar days through no fault of its own, due to any of the following reasons:

- a) Failure of the Procuring Entity to deliver, within a reasonable time, supplies, materials, right-of-way, or other items it is obligated to furnish under the terms of this Contract;
- b) Substantial failure of the Procuring Entity to perform its obligations under the contract, and such failure constitutes a material breach of the Procuring Entity's obligations under the contract;
- c) Prolonged suspension by the Procuring Entity, through no fault of the Contractor, which affects the substantial part of the Infrastructure Project; or
- d) The prosecution of the Work is disrupted by the adverse peace and order situation, as certified by the Armed Forces of the Philippines Provincial Commander and approved by the Secretary of National Defense.

24) Termination for Convenience

The Procuring Entity, by notice sent to the Contractor, may terminate the Contract, in whole or in part, at any time, if it has determined the existence of any of the following conditions that make contract implementation economically, financially, or technically impractical or unnecessary:

- a) If physical and economic conditions have significantly changed so as to render the project no longer economically, financially, or technically feasible, as determined by the HoPE; or
- b) The HoPE has determined the existence of conditions that make project implementation impractical or unnecessary, such as, but not limited to, fortuitous events, changes in laws and government policies.

25) Termination for Unlawful Acts

The Procuring Entity may terminate the contract in case it is determined prima facie that the Contractor, including any joint venture partner therein, has engaged, before or during the implementation of the contract, in unlawful deeds and behaviors relative to contract acquisition and implementation. These unlawful acts include, but are not limited to, the following:

- a) Corrupt, fraudulent, collusive, coercive, and obstructive practices as defined in **ITB** Clause 3.1, unless otherwise specified in the **SCC**;
- b) Drawing up or using forged documents;
- c) Using adulterated materials, means, or methods, or engaging in production contrary to rules of science or trade; or
- d) Any other act analogous to the foregoing.

26) Termination for Other Causes

26.1 The Procuring Entity may terminate this Contract, in whole or in part, at any time for its convenience. The HoPE may terminate this Contract for the convenience of the Procuring Entity if physical and economic conditions have significantly changed so as to render the project no longer economically, financially, or technically feasible, as determined by the HoPE; or if the HoPE has determined the existence of conditions that make project implementation impractical or unnecessary, such as, but not limited to, fortuitous events, changes in laws and government policies.

26.2 The Procuring Entity or the Contractor may terminate this Contract if the other party causes a fundamental breach of this Contract.

26.3 Other breaches of Contract shall include, but shall not be limited to, the following:

- a) The Contractor stops work for twenty-eight (28) days when no stoppage of work is shown on the current Program of Work and the stoppage has not been authorized by the Procuring Entity;
- b) The Procuring Entity instructs the Contractor to delay the progress of the Works, and the instruction is not withdrawn within twenty-eight (28) days;
- c) A payment certified by the Procuring Entity is not paid to the Contractor within eighty-four (84) days from the date of the Procuring Entity's certificate;

- d) The Procuring Entity gives Notice that failure to correct a particular Defect is a fundamental breach of Contract and the Contractor fails to correct it within a reasonable period of time determined by the Procuring Entity;
 - e) The Contractor does not maintain a Security, which is required; and
 - f) The Contractor has delayed the completion of the Works by the number of days for which the maximum amount of liquidated damages can be paid, as defined in the **GCC** 18.
- 26.4 The Funding Source or the Procuring Entity, as appropriate, will seek the imposition of administrative sanctions as prescribed by RA No. 12009 and without prejudice to the imposition of civil and criminal sanctions as provided under applicable against individuals and organizations deemed to be involved with corrupt, fraudulent, or coercive practices.
- 26.5 When persons from either party to this Contract gives notice of a fundamental breach to the Procuring Entity in order to terminate the existing contract for a cause other than those listed under **GCC** Clause 26.3, the Procuring Entity shall decide whether the breach is fundamental or not.
- 26.6 If this Contract is terminated, the Contractor shall stop work immediately, make the Site safe and secure, and leave the Site as soon as reasonably possible.

27) Procedures for Termination of Contracts

- 27.1 The following provisions shall govern the procedures for the termination of this Contract:
- a) **Verification** - Upon receipt of a written report of acts or causes which may constitute grounds for termination as aforementioned, or upon its own initiative, the End-User or Implementing Unit shall, within a period of seven (7) calendar days, verify the existence of such grounds and cause the execution of a Verified Report, with all relevant evidence attached;
 - b) **Notice to Terminate** - Upon recommendation by the End-User or Implementing Unit, the HoPE shall terminate contracts only by written notice to the Contractor conveying the termination of the contract. The notice shall state:
 - (i) that the Contract is being terminated for any of the grounds aforementioned, and a statement of the acts that constitute the grounds constituting the same;
 - (ii) the extent of termination, whether in whole or in part;
 - (iii) an instruction to the Contractor to show cause as to why this contract should not be terminated; and
 - (iv) special instructions of the Procuring Entity, if any.

The Notice to Terminate shall be accompanied by a copy of the Verified Report;

- c) **Show Cause** - Within a period of seven (7) calendar days from receipt of the Notice of Termination, the Contractor shall submit to the HoPE a verified position paper stating why the contract should not be terminated. If the Contractor fails to show cause after the lapse of the seven (7) day period, either by inaction or by default, the HoPE shall issue an order terminating the contract;
- d) **Rescission of Notice of Termination** - The Procuring Entity may, at any time before receipt of the Contractor's verified position paper, withdraw the Notice to Terminate if it is determined that certain items or works subject of the notice had been completed, delivered, or performed before the Contractor's receipt of the notice;
- e) **Decision** - Within a non-extendible period of ten (10) calendar days from receipt of the verified position paper, the HoPE shall decide whether or not to terminate the contract. It shall serve a written notice to the Contractor of its decision and, unless otherwise provided, the contract is deemed terminated from receipt of the Contractor of the notice of the decision. The termination shall only be based on the grounds stated in the Notice to Terminate.
- f) **Contract Termination Review Committee (CTRC)** - The HoPE may create a committee to assist him in the discharge of its functions under the IRR. All decisions recommended by the CTRC shall be subject to the approval of the HoPE
- g) **Take-over of Contracts** - If a Procuring Entity terminates the contract due to default, insolvency, or for cause, it may enter into a Negotiated Procurement (Take-over of Contracts) pursuant to Section 35.3 of the IRR.
- h) **Notice by Contractor** - The Contractor must serve a written notice to the Procuring Entity of its intention to terminate the contract at least thirty (30) calendar days before its intended termination. The contract is deemed terminated if it is not resumed in thirty (30) calendar days after the receipt of such notice by the Procuring Entity.

27.2 Notwithstanding Section 99 of RA No. 12009 and as provided by applicable laws, the Procuring Entity shall impose on Contractors after the termination of the contract, the penalty of suspension for one (1) year for the first offense, suspension for two (2) years for the second offense from participating in the public bidding process, for violations committed during the contract implementation stage, as stated in the **SCC**.

28) **Approval of Drawings and Temporary Works by the Procuring Entity**

- 28.1 All Drawings prepared by the Contractor for the execution of the Temporary Works, are subject to prior approval by the Procuring Entity before its use.
- 28.2 The Contractor shall be responsible for design of Temporary Works.
- 28.3 The Procuring Entity's approval shall not alter the Contractor's responsibility for design of the Temporary Works.

28.4 The Contractor shall obtain approval of third parties to the design of the Temporary Works, when required by the Procuring Entity.

29) Acceleration and Delays Ordered by the Procuring Entity

29.1 When the Procuring Entity wants the Contractor to finish before the Intended Completion Date, the Procuring Entity will obtain priced proposals for achieving the necessary acceleration from the Contractor. If the Procuring Entity accepts these proposals, the Intended Completion Date will be adjusted accordingly and confirmed by both the Procuring Entity and the Contractor.

29.2 If the Contractor's Financial Proposals for an acceleration are accepted by the Procuring Entity, they are incorporated in the Contract Price and treated as a Variation.

30) Contractor's Right to Claim

If the Contractor incurs cost as a result of any of the events under **GCC** Clauses 22, 23 and 24 in relation to **GCC** Clause 20, the Contractor shall be entitled to the amount of such cost. If as a result of any of the said events, it is necessary to change the Works, this shall be dealt with as a Variation.

31) Dayworks

31.1 Subject to **GCC** Clause 40 on Variation Order, and if applicable as indicated in the **SCC**, the Contractor shall determine the Dayworks rates to be included or indicated in the Bid. The Dayworks rates in the Contractor's bid shall be used for small additional amounts of work only when the Procuring Entity has given written instructions in advance for additional work to be paid for in that way.

31.2 All work to be paid for as Dayworks shall be recorded by the Contractor on forms approved by the Procuring Entity. Each completed form shall be verified and signed by the Procuring Entity within two (2) days of the work being done.

31.3 The Contractor shall be paid for Dayworks subject to obtaining signed Dayworks forms from both the Procuring Entity and Contractor.

32) Early Warning

32.1 The Contractor shall warn the Procuring Entity at the earliest opportunity of specific likely future events or circumstances that may adversely affect the quality of the work, increase the Contract Price, or delay the execution of the Works.

32.2 The Contractor shall cooperate with the Procuring Entity in making and considering proposals for how the effect of such an event or circumstance can be avoided or reduced by anyone involved in the work and in carrying out any resulting instruction of the Procuring Entity. Should such events or circumstances arise which increase the Contract price or delay the execution of Works, the provisions on variation order shall apply.

33) Program of Work

33.1 Within the time stated in the **SCC**, the Contractor shall submit to the Procuring Entity for approval a Program of Work showing the general methods, arrangements, order, and timing for all the activities in the Works.

- 33.2 An update of the Program of Work shall show the actual progress achieved on each activity and the effect of the progress achieved on the timing of the remaining work, including any changes to the sequence of the activities.
- 33.3 The Contractor shall submit to the Procuring Entity for approval an updated Program of Work at intervals no longer than the period stated in the **SCC**. If the Contractor does not submit an updated Program of Work within this period, the Procuring Entity may withhold the amount stated in the **SCC** from the next payment schedule and continue to withhold this amount until the next payment after the date on which the overdue Program of Work has been submitted.
- 33.4 The Procuring Entity's approval of the Program of Work shall not alter the Contractor's obligations. A revised Program of Work produced by the Contractor shall show the effect of any approved Variations, and shall include all Variations. The Contractor may revise the Program of Work, based on the Variation Order, and submit it to the Procuring Entity again.
- 33.5 When the Program of Work is updated, the Contractor shall provide the Procuring Entity with an updated cash flow forecast. The cash flow forecast shall include different currencies, as defined in the Contract, converted as necessary using the Contract exchange rates.

34) Management Conferences

- 34.1 Either the Procuring Entity or the Contractor may require the other to attend a Management Conference. The Management Conference shall review the plans for remaining work and deal with matters raised in accordance with the early warning procedure.
- 34.2 The Procuring Entity shall record the business of Management Conferences and provide copies of the record to those attending the Conference and to the Procuring Entity. The responsibility of the parties for the actions to be taken shall be decided by the Procuring Entity either at the Management Conference or after the Management Conference. The Procuring Entity shall communicate these responsibilities in writing to all who attended the Conference.

35) Bill of Quantities

- 35.1 The Bill of Quantities shall contain items of work for the construction, installation, testing, commissioning of work, materials, and labor among others, to be done by the Contractor.
- 35.2 The Bill of Quantities is used to calculate the Contract Price. The Contractor is paid for the quantity of the work done at the rate in the Bill of Quantities for each item.
- 35.3 If the final quantity of any work item completed differs from the quantity indicated in the Bill of Quantities, and the difference does not exceed twenty-five percent (25%) of the original quantity for that item, the Procuring Entity shall adjust the Contract accordingly.

This shall be allowed only if the total amount of all such changes does not go beyond ten percent (10%) of the total Contract price, subject to applicable laws, rules, and regulations.

- 35.4 If requested by the Procuring Entity, the Contractor shall provide the Procuring Entity with a detailed cost breakdown of any rate in the Bill of Quantities.

36) Instructions, Inspections and Audits

- 36.1 The Procuring Entity shall at all reasonable times during construction of the Works be entitled to examine, inspect, measure and test the materials and workmanship, and to check the progress of the construction.
- 36.2 If the Procuring Entity instructs the Contractor to carry out a test not specified in the Specification to check whether any work has a defect and the test shows that it does, the Contractor shall pay for the test and any samples. In the absence of any defect, the test shall be a compensation event with no adverse consequences to the contractor.
- 36.3 The Contractor shall permit the Funding Source named in the **SCC** to inspect the Contractor's accounts and records relating to the performance of the Contractor and to have them audited by auditors appointed by the Funding Source, if so required by the Funding Source.

37) Identifying Defects

The Procuring Entity shall check the Contractor's work and notify the Contractor of any defects that are found. Such checking shall not affect the Contractor's responsibilities. The Procuring Entity may instruct the Contractor to check noted defects and test any work that the Procuring Entity considers as substandard and/or defective.

38) Correction of Defects

- 38.1 The Procuring Entity shall give notice to the Contractor of any defects before the end of the Defects Liability Period, which is one (1) year from project completion up to final acceptance by the Procuring Entity.
- 38.2 Every time notice of a defect is given, the Contractor shall correct the notified defect within ninety (90) calendar days from the time the HoPE has issued an order to undertake repair.
- 38.3 The Contractor shall correct the defects which they notice themselves before the end of the Defects Liability Period.
- 38.4 The Procuring Entity shall certify that all defects have been duly corrected.

39) Uncorrected Defects

- 39.1 The Procuring Entity shall give the Contractor at least fourteen (14) days' notice of its intention to use a third party to correct a Defect. If the Contractor does not correct the Defect himself within the period, the Procuring Entity may have the Defect corrected by the third party. The cost of the correction will be deducted from the Contract Price.
- 39.2 The use of a third party to correct defects that are uncorrected by the Contractor will in no way relieve the Contractor of its liabilities and warranties under the Contract.

40) Variation Orders

- 40.1 Variation Orders may be issued by the Procuring Entity to cover any increase or decrease in quantities, including the introduction of new work items that are not included in the original contract or reclassification of work items that are either due to change of plans, design or alignment to suit actual field conditions resulting in disparity between the preconstruction plans used for purposes of bidding and the "as staked plans" or construction drawings prepared after a joint survey by the Contractor and the Government after award of the contract.

Provided, That in case of positive or additive Variation Order/s, the cumulative amount thereof shall not exceed ten percent (10%) of the original contract price; Provided, further, That the scope of works shall not be reduced as to accommodate a positive Variation Order. In all cases, the addition of works under Variation Orders should be within the general scope of the project as bid and awarded.

- 40.2 Any cumulative positive Variation Order beyond ten percent (10%) of the original contract price shall be the subject of another procurement project to be bid out if the Works are separable from the original contract. In exceptional cases where it is urgently necessary to complete the original scope of work, the HoPE, upon the recommendation of the End-User or Implementing Unit, may authorize positive Variation Order/s resulting to a cumulative value of the positive Variation Orders beyond ten percent (10%) but not more than twenty percent (20%) of the original contract price.

All progress payments shall first be charged against the advance payment until the latter has been fully exhausted, at the option of the Procuring Entity.

- 40.3 A Variation Order may either be in the form of a Change Order or Extra Work Order:

- a) A Change Order may be issued by the HoPE or duly authorized representative to cover any increase or decrease in quantities of original work items in the contract.
- b) An Extra Work Order may be issued by the implementing official to cover the introduction of new work necessary for the completion, improvement or protection of the project which was not included as items of work in the original contract, such as, where there are subsurface or latent physical conditions at the site differing materially from those indicated in the contract, or where there are duly unknown physical conditions at the site of an unusual nature differing materially from those ordinarily encountered and generally recognized as inherent in the work or character provided for in the contract.

- 40.4 For Variation Orders, the Contractor shall be paid for additional work items whose unit prices shall be derived based on the following:

- a) For additional or extra works duly covered by Change Orders involving work items which are exactly the same or similar to those in the original contract, the applicable unit prices of work items original contract shall be used.

- b) For additional or extra works duly covered by Extra Work Orders involving new work items that are not in the original contract, the unit prices of the new work items shall be based on the direct unit costs used in the original contract (e.g., unit cost of cement, rebars, form lumber, labor rate, equipment rental, etc.). All new components of the new work item shall be fixed prices; Provided, The same is acceptable to both the Government and the Contractor; Provided further, That the direct unit costs of new components shall be based on the Contractor's estimate as validated by the Procuring Entity concerned via documented canvass in accordance with existing rules and regulations. The direct cost of the new work item shall then be combined with the mark-up factor (i.e., taxes and profit) used by the Contractor in its bid to determine the unit price of the new work item.

40.5 Under no circumstances shall a Contractor proceed to commence work under any Change Order or Extra Work Order unless it has been approved by the HoPE or its duly authorized representative. However, under any of the following conditions, the Procuring Entity's representative or Project Engineer may, subject to the availability of funds and within the limits of its delegated authority, allow the immediate start of work under any Change Order or Extra Work Order:

- a) In the event of an emergency where the prosecution of the work is urgent to avoid detriment to public service, or damage to life and/or property; and/or
- b) When time is of the essence;

Provided, however, That such approval is valid on work done up to the point where the cumulative increase in value of work on the project which has not yet been duly fully approved does not exceed five percent (5%) of the adjusted original contract price.

Provided, further, That immediately after the start of work, the corresponding Change Order or Extra Work Order shall be prepared and submitted for approval in accordance with the abovementioned rules. Payments for Works satisfactorily accomplished on any Change Order or Extra Work Order may be made only after approval of the same by the HoPE or its duly authorized representative.

Provided, finally, That for a Change Order or Extra Work Order involving a cumulative amount exceeding five percent (5%) of the original contract price, no work thereon may be commenced unless said Change Order or Extra Work Order has been approved by the HoPE or its duly authorized representative.

41) Contract Completion

Once the project reaches an accomplishment of ninety-five percent (95%) of the total contract amount, the Procuring Entity may constitute an inspectorate team to conduct preliminary inspection and submit a punch-list to the Contractor in preparation for the final turnover of the project. Said punch-list will contain, among others, the remaining Works, Work deficiencies for necessary corrections, and the specific duration/time to fully complete the project within the approved remaining contract time. This, however, shall not preclude the claim of the Procuring Entity for liquidated damages, if applicable.

42) Suspension of Work

- 42.1 The Procuring Entity shall have the authority to suspend the work wholly or partly by written order for such period as may be deemed necessary, due to *force majeure* or any fortuitous event or for failure on the part of the Contractor to correct bad conditions which are unsafe for workers or for the general public, to carry out valid orders given by the Procuring Entity or to perform any provisions of the contract, or due to adjustment of plans to suit field conditions as found necessary during construction. The Contractor shall immediately comply with such order to suspend the work wholly or partly.
- 42.2 The Contractor or its duly authorized representative shall have the right to suspend work operation on any or all projects or activities along the critical path of activities after fifteen (15) calendar days from date of receipt of written notice from the Contractor to the district engineer, regional director, consultant or equivalent official, as the case may be, due to the following:
- a) There exist right-of-way problems which prohibit the Contractor from performing work in accordance with the approved construction schedule.
 - b) Requisite construction plans which must be owner furnished are not issued to the Contractor precluding any work called for by such plans.
 - c) Peace and order conditions that make it extremely dangerous, if not possible, to work. However, this condition must be certified in writing by the Philippine National Police station which has responsibility over the affected area and confirmed by the Department of the Interior and Local Government (DILG) Regional Director.
 - d) There was a failure on the part of the Procuring Entity to deliver government-furnished materials and equipment as stipulated in the contract.
 - e) Delay in the payment of Contractor's claim for progress billing beyond forty-five (45) calendar days from the time the Contractor's claim has been certified by the Procuring Entity's authorized representative that the documents are complete, unless there are justifiable reasons for the delay in payment which shall be communicated in writing to the Contractor.
- 42.3 In case of total suspension, or suspension of activities along the critical path, which is not due to any fault of the Contractor, the elapsed time between the effectivity of the order suspending operation and the order to resume work shall be allowed to the Contractor by adjusting the contract time accordingly.

43) Payment on Termination

- 43.1 If the Contract is terminated because of a breach of Contract by the Contractor, the Procuring Entity shall issue a certificate for the value of the work done and Materials ordered less advance payments received up to the date of the issue of the certificate, and less the percentage to apply to the value of the work not completed, as indicated in the **SCC**. Additional liquidated damages shall not apply. If the total amount due to the Procuring Entity exceeds any payment

due to the Contractor, the difference shall be a debt payable to the Procuring Entity.

- 43.2 If the Contract is terminated for the Procuring Entity's convenience, or due to a breach of Contract by the Procuring Entity, the Procuring Entity shall issue a certificate for the value of the work done, Materials ordered, the reasonable cost of removal of Equipment, repatriation of the Contractor's personnel employed solely on the Works, and the Contractor's costs of protecting and securing the Works, and less advance payments received up to the date of the certificate.
- 43.3 The net balance due shall be paid or repaid within twenty-eight (28) days from the notice of termination.
- 43.4 If the Contractor has terminated the Contract under **GCC** Clauses 23 to 24, the Procuring Entity shall promptly return the Performance Security to the Contractor.

44) Extension of Contract Time

- 44.1 Should the amount of additional work or other special circumstances warrant the entitlement of the Contractor to an extension of contract time, the Procuring Entity shall determine the amount of such extension; Provided, That the Contractor has notified the Procuring Entity of its claim for extension of contract time prior to the expiration of the contract time, and within thirty (30) calendar days after the additional work has been commenced or the circumstances leading to such claim have arisen, as the case may be, in order to give the Procuring Entity the opportunity to investigate the claim. Failure to provide such notice shall constitute a waiver of such a claim by the Contractor. Upon receipt of full and detailed particulars, the Procuring Entity shall examine the facts and extent of the delay and shall extend the contract time to complete the contract work when, in the Procuring Entity's opinion, the findings of facts justify an extension.
- 44.2 No extension of contract time shall be granted to the Contractor due to ordinary unfavorable weather conditions and inexcusable negligence of the Contractor to provide the required equipment, supplies, or materials.
- 44.3 Extension of contract time may be granted only when the affected activities fall within the critical path of the PERT, CPM, Precedence Diagram Method or any other project management tool.
- 44.4 No extension of contract time shall be granted when the reason given to support the request for extension was already considered in the determination of the original contract time during the conduct of detailed engineering and in the preparation of the contract documents as agreed upon by the parties before contract perfection.
- 44.5 Extension of contract time may be granted in the cases indicated in the **SCC**.
- 44.6 The written consent of the bank, or surety or insurance company, as the case may be, must be attached to any request of the Contractor for extension of contract time and submitted to the Procuring Entity for consideration and the validity of the Performance Security shall be correspondingly extended.

- 44.7 The Procuring Entity shall extend the Intended Completion Date if a Variation is issued which makes it impossible for the Intended Completion Date to be achieved by the Contractor without taking steps to accelerate the remaining work, which would cause the Contractor to incur additional costs. No payment shall be made for any event which may warrant the extension of the Intended Completion Date.
- 44.8 The Procuring Entity shall decide whether and by how much to extend the Intended Completion Date within twenty (20) days of the Contractor asking the Procuring Entity for a decision thereto after fully submitting all supporting information. If the Contractor has failed to give early warning of a delay or has failed to cooperate in dealing with a delay, the delay by this failure shall not be considered in assessing the new Intended Completion Date.

45) Price Escalation

In the event of an extraordinary increase in prices of specific components of the Infrastructure Project, price escalation may be considered, subject to prior approval of the GPPB. If the cost of construction components increases by more than ten percent (10%) of the unit price of work items, as determined against the prevailing price indices of the PSA, a price escalation may be authorized at a no-loss, no-gain basis, using the appropriate formula prescribed by the GPPB. For the purpose of this Section, the PSA shall ensure that its price indices are region-specific and updated on a monthly basis

46) Completion

The Contractor shall request the Procuring Entity to issue a Certificate of Completion of the Works, and the Procuring Entity will do so upon determining that the work is completed.

47) Taking Over

The Procuring Entity shall take over the Site and the Works within seven (7) days from the date of issuance of a Certificate of Completion; Provided, That it shall not release the Contractor of its responsibilities within the defects liability period.

48) Operating and Maintenance Manuals

- 48.1 If “as built” Drawings and/or operating and maintenance manuals are required, the Contractor shall supply them by the dates stated in the **SCC**.
- 48.2 If the Contractor does not supply the Drawings and/or manuals by the dates stated in the **SCC**, or they do not receive the Procuring Entity’s approval, the Procuring Entity shall withhold the amount stated in the **SCC** from payments due to the Contractor.

Section V. Special Conditions of Contract

Notes on the Special Conditions of Contract

Similar to the BDS, the clauses in this Section are intended to assist the Procuring Entity in providing contract-specific information in relation to corresponding clauses in the GCC.

The provisions of this Section complement the GCC, specifying contractual requirements linked to the special circumstances of the Procuring Entity, the Procuring Entity's country, the sector, and the Works procured. In preparing this Section, the following aspects should be checked:

- a) Information that complements provisions of Section IV. General Conditions of Contract must be incorporated.
- b) Amendments and/or supplements to provisions of Section IV. General Conditions of Contract, as necessitated by the circumstances of the specific project, must also be incorporated.

However, no special condition which defeats or negates the general intent and purpose of the provisions of Section IV. General Conditions of Contract should be incorporated herein.

Special Conditions of Contract

GCC Clause																									
1.1	The Intended Completion Date is 270 Calendar Days from the date of receipt of the Notice To Proceed (NTP) .																								
1.2	The Procuring Entity is TESDA- Regional Office II, Carig Norte, Tuguegarao City, Cagayan .																								
1.3	The Site is located at TESDA-ISAT, Calamagui 2nd, City of Ilagan, Isabela and is defined in drawings No. A-1 .																								
1.4	The Start Date is Upon receipt of the Notice To Proceed (NTP) .																								
1.5	The Works consist of Creation of Isabela of School of Arts and Trades Diploma Center with Six (6) Class rooms, One (1) Laboratory room, Library, Clinic, Faculty rooms and Restrooms .																								
2.2	No Further Instructions																								
5.1	The Procuring Entity shall give possession of all parts of the Site to the Contractor at the start date .																								
6.5	<p>The Contractor shall employ the following Key Personnel:</p> <table border="1" style="width: 100%; border-collapse: collapse;"> <thead> <tr> <th style="text-align: center;"><u>Key Personnel</u></th> <th style="text-align: center;"><u>General Experience</u></th> <th style="text-align: center;"><u>Relevant Experience</u></th> </tr> </thead> <tbody> <tr> <td style="text-align: center;">Project Engineer</td> <td style="text-align: center;">Building</td> <td style="text-align: center;">5 years</td> </tr> <tr> <td style="text-align: center;">Materials Engineer I</td> <td style="text-align: center;">General Construction</td> <td style="text-align: center;">5 years</td> </tr> <tr> <td style="text-align: center;">Construction Foreman (Holder of NC II)</td> <td style="text-align: center;">Building</td> <td style="text-align: center;">5 years</td> </tr> <tr> <td style="text-align: center;">Scaffolder (Holder of NC II)</td> <td style="text-align: center;">Building</td> <td style="text-align: center;">5 years</td> </tr> <tr> <td style="text-align: center;">Skilled Workers</td> <td style="text-align: center;">Building</td> <td style="text-align: center;">5 years</td> </tr> <tr> <td style="text-align: center;">Construction Safety Officer</td> <td style="text-align: center;">With Certificate of Training accredited by DOLE</td> <td style="text-align: center;">With Certificate of Training accredited by DOLE</td> </tr> <tr> <td style="text-align: center;">First Aider</td> <td style="text-align: center;">With Certificate of Training issued by Red Cross</td> <td style="text-align: center;">With Certificate of Training issued by Red Cross</td> </tr> </tbody> </table>	<u>Key Personnel</u>	<u>General Experience</u>	<u>Relevant Experience</u>	Project Engineer	Building	5 years	Materials Engineer I	General Construction	5 years	Construction Foreman (Holder of NC II)	Building	5 years	Scaffolder (Holder of NC II)	Building	5 years	Skilled Workers	Building	5 years	Construction Safety Officer	With Certificate of Training accredited by DOLE	With Certificate of Training accredited by DOLE	First Aider	With Certificate of Training issued by Red Cross	With Certificate of Training issued by Red Cross
<u>Key Personnel</u>	<u>General Experience</u>	<u>Relevant Experience</u>																							
Project Engineer	Building	5 years																							
Materials Engineer I	General Construction	5 years																							
Construction Foreman (Holder of NC II)	Building	5 years																							
Scaffolder (Holder of NC II)	Building	5 years																							
Skilled Workers	Building	5 years																							
Construction Safety Officer	With Certificate of Training accredited by DOLE	With Certificate of Training accredited by DOLE																							
First Aider	With Certificate of Training issued by Red Cross	With Certificate of Training issued by Red Cross																							
7.1	No further instructions.																								
8.1	The amount of the advance payment is Fifteen Percent (15%) of the Contract Price, to be made in lump sum .																								

9.1	Materials and equipment delivered onsite but not yet incorporated in the Works shall be included for payment.
9.4	<p>The advance payment shall be repaid by the contractor by deducting fifteen percent (15%) from his periodic progress payments a percentage equal to the percentage of the total contract price used for the advance payment.</p> <p>The first progress payment may be paid by the Procuring Entity to the Contractor; Provided, That at least Thirty Percent (30%) of the Works has been accomplished as certified by the Procuring Entity.</p>
12.7	No further instructions.
13.1	The site investigation reports are: NONE
15.3	No further instructions.
15.5	<i>In case of permanent structures, such as buildings of types 4 and 5 as classified under the National Building Code of the Philippines and other structures made of steel, iron, or concrete which comply with relevant structural codes (e.g., DPWH Standard Specifications), such as, but not limited to, steel/concrete bridges, flyovers, aircraft movement areas, ports, dams, tunnels, filtration and treatment plants, sewerage systems, power plants, transmission and communication towers, railway system, and other similar permanent structures: Fifteen (15) years.</i>
19.2	The Arbitrator is the person appointed jointly by the Procuring Entity and the Contractor: To be determined after the award of the Contract
20	No additional provision.
25(a)	No further instructions.
27.2	<p>a) Failure of the Contractor, due solely to its fault or negligence, to mobilize and start work or performance within the specified period in the Notice to Proceed (“NTP”);</p> <p>b) Failure by the Contractor to fully and faithfully comply with its contractual obligations without valid cause, or failure by the Contractor to comply with any written lawful instruction of the Procuring Entity or its representative(s) pursuant to the implementation of the contract. For the procurement of infrastructure projects or consultancy contracts, lawful instructions include but are not limited to the following:</p> <p>i) Employment of competent technical personnel, competent engineers and/or work supervisors;</p> <p>ii) Provision of warning signs and barricades in accordance with approved plans and specifications and contract provisions;</p>

	<p>iii) Stockpiling in proper places of all materials and removal from the project site of waste and excess materials, including broken pavement and excavated debris in accordance with approved plans and specifications and contract provisions;</p> <p>iv) Deployment of committed equipment, facilities, support staff and manpower; and</p> <p>v) Renewal of the effectivity dates of the performance security after its expiration during the course of contract implementation.</p> <p>c) Assignment and subcontracting of the contract or any part thereof or substitution of key personnel named in the proposal without prior written approval by the Procuring Entity.</p> <p>d) Poor performance by the Contractor or unsatisfactory quality and/or progress of work arising from its fault or negligence as reflected in the CPES rating sheet. In the absence of the CPES rating sheet, the existing performance monitoring system of the Procuring Entity shall be applied. Any of the following acts by the Contractor shall be construed as poor performance:</p> <p>i) Negative slippage of fifteen (15%) and above within the critical path of the project due entirely to the fault or negligence of the Contractor; and</p> <p>ii) Quality of materials and workmanship not complying with the approved specifications arising from the Contractor's fault or negligence.</p> <p>e) Willful or deliberate abandonment or non-performance of the project or contract by the Contractor resulting to substantial breach thereof without lawful and/or just cause.</p> <p>In addition to the penalty of suspension, the performance security posted by the Contractor shall also be forfeited.</p>
31.1	No dayworks are applicable to the contract.
33.1	The Contractor shall submit the Program of Work to the Procuring Entity within 2 days of delivery from the Notice of Award.
33.3	The period between Program of Work updates is 5 Days prior to the Request for Progress Billing.
	The amount to be withheld for late submission of an updated Program of Work is One Percent (1%) of the contract price .
36.3	The Funding Source is the <i>Government of the Philippines.</i>
43.1	The percentage to apply to the value of the work not completed is Ten Percent (10%).

44.5	<p><i>Cases when extension of contract time may be granted which may include the enumeration below:</i></p> <p>a) rainy/unworkable days considered unfavorable for the prosecution of the Works at the site, based on the actual conditions obtained at the site, in excess of the number of rainy/unworkable days pre-determined by the Procuring Entity in relation to the original contract time during the conduct of detailed engineering and in the preparation of the contract documents as agreed upon by the parties before contract perfection, and/or</p> <p>b) major calamities such as exceptionally destructive typhoons, floods and earthquakes, and epidemics,</p> <p>c) delays attributable to the Procuring Entity, such as non-delivery on time of materials, working drawings, or written information to be furnished by the Procuring Entity, non-acquisition of permit to enter private properties or non-execution of deed of sale or donation within the right-of-way resulting in complete paralyzation of construction activities, and</p> <p>d) other meritorious causes as determined by the Procuring Entity and approved by the HoPE such as shortage of construction materials, general labor strikes, and peace and order problems that disrupt construction operations through no fault of the Contractor may be considered as additional grounds for extension of contract time provided they are publicly felt and certified by appropriate government agencies such as DTI, DOLE, DILG, and DND, among others.</p>
48.1	<p>The date by which operating and maintenance manuals are required is Upon issuance of the Certificate of Completion.</p> <p>The date by which “as built” drawings are required is Upon issuance of the Certificate of Completion.</p>
48.2	<p>The amount to be withheld for failing to produce “as built” drawings and/or operating and maintenance manuals by the date required is One Percent (1%).</p>

Section VI. Specifications

Notes on Specifications

A set of precise and clear specifications is a prerequisite for Bidders to respond realistically and competitively to the requirements of the Procuring Entity without qualifying or conditioning their Bids. In the context of Competitive Bidding, Limited Source Bidding, or Competitive Dialogue, the specifications must be drafted to permit the widest possible competition and, at the same time, present a clear statement of the required standards of workmanship, materials, and performance of the goods and services to be procured. Only if this is done will the objectives of economy, efficiency, and fairness in procurement be realized, responsiveness of Bids be ensured, and the subsequent task of bid evaluation facilitated. The specifications should require that all goods and materials to be incorporated in the Works be new, unused, of the most recent or current models, and incorporate all recent improvements in design and materials unless provided otherwise in the Contract.

Samples of specifications from previous similar projects are useful in this respect. The use of metric units is mandatory. Most specifications are normally written specially by the Procuring Entity or its representative to suit the Works at hand. There is no standard set of Specifications for universal application in all sectors in all regions, but there are established principles and practices, which are reflected in these PBD.

There are considerable advantages in standardizing General Specifications for repetitive Works in recognized public sectors, such as highways, ports, railways, urban housing, irrigation, and water supply, in the same country or region where similar conditions prevail. The General Specifications should cover all classes of workmanship, materials, and equipment commonly involved in construction, although not necessarily to be used in a particular Works Contract. Deletions or addenda should then adapt the General Specifications to the particular Works.

Prudence must be exercised in drafting specifications to ensure that they are not restrictive. In the specification of standards for goods, materials, and workmanship, recognized international standards should be used as much as possible. Where other particular standards are used, whether national standards or other standards, the specifications should state that goods, materials, and workmanship that meet other authoritative standards, and which ensure substantially equal or higher quality than the standards mentioned, will also be acceptable.

The following clause may be inserted in the SCC:

Sample Clause: Equivalency of Standards and Codes

Wherever reference is made in the Contract to specific standards and codes to be met by the goods and materials to be furnished, and work performed or tested, the provisions of the latest current edition or revision of the relevant standards and codes in effect shall apply, unless otherwise expressly stated in the Contract. Where such standards and codes are national, or relate to a particular country or region, other authoritative standards that ensure a substantially equal or higher quality than the standards and codes specified will be accepted subject to the Procuring Entity's prior review and written consent. Differences between the standards specified and the proposed alternative standards shall be fully described in writing by the Contractor and submitted to the Procuring Entity at least twenty-

eight (28) days prior to the date when the Contractor desires the Procuring Entity's consent. In the event the Procuring Entity determines that such proposed deviations do not ensure substantially equal or higher quality, the Contractor shall comply with the standards specified in the documents.

These notes are intended only as information for the Procuring Entity or the person drafting the Bidding Documents. They should not be included in the final Bidding Documents.

A.INFRASTRUCTURE TECHNICAL SPECIFICATIONS

1-0 SPECIFICATION

1-10 SCOPE OF WORK

The work to be performed under these specifications were consist of; Furnishing of all labor and materials based in plans and to complete the structure or building, in accordance with these specifications and working drawings, and with the application of the specifications for Concrete and Reinforced Concrete of the Department of Public Works and Highways, as modified in the terms and conditions of the contract.

1-02 WORK TO BE DONE

The principal operations to be performed under these specifications include the clearing, grubbing, grading, backfilling, construction of building or structure, including the installation of the complete plumbing fixtures and systems, complete electrical system and such other operations as may be necessary for the completion of construction building or structure, with accordance with these specification plans and working drawings.

1-03 FOUNDATION

The footings for columns, walls and shear walls, shall rest or extended to firm and undisturbed soil.

1-04 BUILDING PERMITS

Building permit and other permits fee shall be solely borne by the agency, not unless included in the contractors schedule of fee as agreed upon.

1-05 LAWS TO BE OBSERVED

The contractor shall comply all laws, Municipal and Barangay Ordinances and all government specifications as provided by the national Building Code of the Philippines.

2-00 GENERAL SPECIFICATION

2-01 MATERIALS

All parts of the building shall be of such materials as shown and specified in the working drawings, and shall comply with the quality and quantity of the required materials. Substitution of other type or kind of materials shall be made only if and only if the Owner and Contractor agreed on it for the completion and proper execution of the work.

2-02 WORKMANSHIP

All operations required under any and all parts of the specifications be undertaken in a neat, and proper workman like manner. Only skilled personnel with sufficient experiences in the similar operations shall be allowed to perform the work

2-03 LINES AND GRADES

The building shall be staked out and grades established by the Civil Engineer or Architect. The contractor shall store materials and conduct the work in such a manner as to preserve marks set by the Engineer/Architect.

2-04 CLEARING, GRUBBING, AND GRADING

The contractor shall clear, grub, and grade the site in all directions from the building line within the property. Building line shall be understood to be the main exterior wall surface of the building or structure. Grubbing shall be carried to such a depth as to insure removal of all roots.

2-05 ORDERS

Whenever the Contractor is not at the site, orders may be given by the Owner or his authorized representative, and shall be accepted and complied with by the superintendent or foreman of the contractor.

2-06 WATER SUPPLY

For all the operations required in the executions of this contract, the Contractor shall provide at his expense an ample fresh water supply under a pressure sufficient for all construction purposes.

2-07 CLEAN-UP

The Contractor, prior to the turn-over of the work to the Owner shall removed any rubbish from the premises and tools, scaffolding, equipment and materials not the part of the finished structure.

2-08 CONFLICT BETWEEN PLANS AND SPECIFICATIONS

For any conflict between plans/working drawings and specifications shall be conformed with the Engineer or Architect for further verification and for final decision. Deletion of any works under the specifications of works to be undertaken but necessary for completion of the work, shall be undertaken by the contractor without any extra fee.

3-00 CONCRETE MASONRY AND FINISHING WORKS

3-01 SCOPE

The work covered by this part of the Specifications consists in furnishing all plants, labor, equipment and materials and performed all necessary operation in connection with the concrete, masonry and stucco works of the building, complete, in accordance with these Specification, the applicable Drawings and provisions of the Department of Public Works, "Specification

for Concrete and Reinforced concrete', and subject to the items and condition of the Contract.

3-02 GENERAL

All works must be done in a neat and workman like manner. All wearing surfaces of floors, shall be finished with 1:2 mortar one (1cm) centimeter thick. All intersections of walls with concrete floor shall be provided with rounded fillets on (1") inch radius.

3-03 PROPORTIONING OF CONCRETE

The following proportions shall be used, unless otherwise indicated in the Drawings:

Class "A" – (1:2:4) Concrete shall be used for footings, columns, and beams.

Class "B" – (1:2-1/2:5) Concrete shall be used for slabs on wood fillers.

Class "C" – (1:3:6) Concrete shall be used for concrete slabs on fill.

4-00 CERAMICS OR VITRIFIED FLOORING, WALL TILE WORKS

4-01 GENERAL

All tile containers shall be delivered to the site with labels intact and seals unbroken, subject to inspection by the Architect/Engineer before being opened. Colors and pattern shall be as selected by the Architect/Engineer prior to then commencement of the work.

Additionally, samples will be provided by the contractor and from which the HoPE or its authorized representative/s shall select and approve.

4-02 MATERIALS

Floor tiles shall be granite/ceramics type, unglazed/glazed nominal 60 x 60 cm five sixteenths (5/16") inch thick with cushion edges. Wall tiles shall be glazed type, high gloss finish, nominal size 30 x 60 cm with complete accessories such as edging, capping's and others to complete the entire tile works. The adhesive and grout is a must in any tile works.

5-00 CARPENTRY AND JOINERY WORKS

5.01 GENERAL

Lumber shall be of approved quality and of the sizes and species required for every particular part of the work. Lumber shall well-seasoned, dry and free from any common wood defects or other imperfections that may impair its strength, durability or physical appearance. Framing lumber shall be nominal sizes or dimensions shown in the drawings.

All exposed woodworks shall be smoothly dressed and exposed and sandpapered.

5-02 KINDS OF LUMBER

Unless otherwise indicated in the Plans or specified hereinafter, use:

- a. Tanguile – for formworks of column, beam and stair.

5-03 WOOD IN CONTACT WITH MASONRY

All wood surfaces to be in contact with or embedded in masonry concrete or cement mortar shall be painted with hot asphalt coal tar and securely anchored with 30D nails spaced at approximately thirty (30 cm) centimeters on center.

5-04 CEILINGS

All ceiling boards shall be ¼” x 4’ x 8’ fiber cement board unless otherwise specified in the Drawings. Boards shall be screwed to the metal furring and screwing strips in the pattern as shown in the Drawings with screws evenly spaced in straight lines at eight (16-24”) sixteen to twenty-four inches on center, each way. unless furtherly specified in working drawings.

6-00 HARDWARES

Used the specified type of hardwares base on the approved program of works, no generic brand shall be used without the approval of an Engineer/Architects. All hardwares must be a branded type and meant for a heavy duty.

6-01 SCOPE

The work covered by this part of the Specifications consists in furnishing and installation of all rough and finished hardwares, complete in accordance with these Specifications and applicable Drawing and subjects to the terms and conditions of the Contract.

6-02 GENERAL

The Contractor shall install all hardware in the most approved manner with all exposed screws matching the surrounding finish. Care shall exercise not to major injure existing works. All hardware shall function freely. The Contractor shall also furnish and install any hardware necessary to leave the work complete although not specifically mentioned herein, and all such hardwares shall conform in quality and finish to the rest of the hardwares specified.

6-03 KEYS

Each lock shall have two (2) keys with the lock number stamped on them. A list of the locks with the corresponding key numbers shall be submitted in duplicate to the Architect, upon completion of the work. Each lock shall be keyed differently from every other lock in the building.

- a. Finish hardware location – unless otherwise required, locate hardware as follows:
 1. Door knobs – 1.00 m_ from center line of knob to finished floor line.
 2. Door pull – 1.00 m_ from center line of grip to finished floor line.
- b. Number of hinges to be furnished for each door shall be determined as follows:
 1. For doors 1.5 m_ but less than 2.10 m high, provide three (3) butts to a sash.
 2. For doors over 2.10 - 3.0 m high, provide four butt hinges, stainless steel finish by “Stanley” or its total equivalent.

Use 2” x 4” loose pin, butt hinges, stainless steel finish by “Stanley” brand.

6-0 LOCKSET

For exterior panel doors, and interior panel doors, use “Schrage” chromium plated. All other doors not covered by specifications shall be provided with corresponding and appropriate locks falling under the same qualifications or classifications and quality as specified.

7-00 TINSMITHRY WORKS

Used the approved gauge or thickness 0.60mm thick rib type pre-painted roofings and other roofing accessories such as ridge roll, valley gutter, end flashing, wall flashing, gutters and all roofing accessories. The thickness of all roofing accessories must be measured by a caliper (Metal Base Thickness). Used the standard approved quality of metal tek screw to fasten all the roofing accessories.

8-00 PLUMBING FIXTURES

8-01 SCOPE

The work covered by this part of the specification consists in the furnishing all materials, labor equipment tools and other supplies upon performing all operations for the installations of the plumbing system of the building or structure.

8-02 WORKMANSHIP

Workmanship throughout shall correspond to the standard of best practice, and all work shall be undertaken by an experience plumber under the direct supervision of a licensed Master Plumber, for works not shown in the working drawings, or where changes are required to harmonize with the work of other trades, the Contractor shall follow the instructions of the Engineer or Architect. Upon completion of the work, the contractor shall obtain, at his expense, from authorized City, Provincial, Municipal, and barangay Officials all proper certificates showing that the work has been performed satisfactory.

8-03 PLUMBING FIXTURES

Downspout and catch basin

- a. Use specified size of polyurethane vinyl pipe (PVC) series 1000 or Reinforced concrete pipe as specified in the program of work/plans and drawings.
- b. Provision of inter connected concrete catch basin and clean out man hole (safely covered) towards the existing public canal for proper disposal of surface run-off water.

9-00 GENERAL

All plumbing connections shall be made in accordance with the Sanitary Code of the City and or locality.

9-01 WATER CLOSETS, LAVATORIES, URINALS AND FLOOR DRAIN

Provide Elongated Wall Mounted Solar Powered Sensor Toilet, Lavatory with Automatic Touchless Faucet, Smart Censor Urinals and Stainless Steel Rectangular Floor Drain with complete set of soap and tissue holder. All exposed metal shall be chromium plated.

10-00 ELECTRICAL SYSTEM AND FIXTURES

10-01 GENERAL

This document presents the technical specifications for the electrical works for a multi-story school building. These specifications are designed to ensure the safe and efficient installation, operation, and maintenance of electrical systems and equipment in compliance with the local electrical code and regulations. The contractor shall be a licensed electrician or Electrical Engineer to execute the work as per requirements of the city or locality and the contractor shall be responsible for the correct performance of the work in accordance with the furnished Plans and Specifications. Any transaction in connection with the Electrical System shall be done thru the Contractor. Under these Specifications, the contractor shall furnish all materials and labor and shall install in the building in accordance with the plans and specifications. All necessary inspections and permits shall be obtained by and at the expense of the contractor. All materials appliances and fittings used hereunder shall be the type and manufacture approved by the Philippine Fire Prevention Rules and Regulation or Philippine Electrical Code.

10-02 SCOPE

The electrical works shall encompass the design, supply, installation, testing, and commissioning of all electrical systems and equipment required for the school building, including but not limited to:

- a. Power distribution systems

- b. Lighting systems
- c. Emergency backup power systems
- d. Fire and safety systems

10-03 ELECTRICAL DESIGN

- a. The electrical systems and equipment design shall conform to the requirements of the Philippine Electrical Code (PEC) and other relevant regulatory standards.
- b. The design shall prioritize energy efficiency through the use of LED lighting fixtures, power-saving strategies, and properly sized electrical components.
- c. Adequate provisions shall be made for future expansion and load requirements, ensuring flexibility in the electrical design.

10-04 POWER DISTRIBUTION SYSTEMS

- a. The electrical supply shall be sourced from the Distribution Utility or Local Electric Cooperative, complying with the requirements of the DU/ LEC (if applicable).
- b. The power distribution system shall be designed to maintain proper load balancing, taking into account the power requirements of different areas and rooms.
- c. Electrical panels and distribution boards shall be clearly labeled and marked to facilitate easy identification and maintenance of circuits and breakers.

10-05 LIGHTING SYSTEMS

- a. The lighting design shall provide appropriate illumination in different areas, including classrooms, corridors, laboratories, and offices, meeting the requirements of the Philippine Lighting Code.
- b. Energy-efficient LED lighting fixtures shall be used throughout the building, with a focus on providing glare-free lighting and optimizing energy consumption.
- c. Lighting control systems shall be implemented, allowing manual or automated control of lighting levels in accordance with occupant needs and daylight availability.

10-06 EMERGENCY BACKUP POWER SYSTEMS

- a. A standby generator with adequate capacity shall be installed to ensure an uninterrupted power supply during utility outages or emergencies.

b. The generator shall be equipped with an automatic transfer switch (ATS) that seamlessly switches the power supply from the utility grid to the backup generator upon detecting a power interruption.

c. The backup power system shall be designed to provide electricity to critical systems, such as emergency lighting, fire alarms, elevators, water pumps, and essential equipment.

Above mentioned, if applicable or if included in the Program of Works and Plans.

10-07 FIRE AND SAFETAY SYSTEMS

a. Smoke detectors, heat detectors, and fire alarm systems shall be installed as per the guidelines of the Bureau of Fire Protection (BFP) and other relevant fire safety regulations.

b. Emergency lighting systems shall be provided to illuminate exit paths and key areas during power outages or emergencies.

c. Proper earthing systems shall be installed to ensure effective grounding of electrical equipment and minimize the risk of electric shock and fire hazards.

Note: Above mentioned, if applicable or if included in the Program of Works and Plans.

10-08 LIGHTNING PROTECTION SYSTEMS

a. A lightning protection system shall be installed to mitigate the risk of lightning strikes and protect the building and its occupants.

b. The system shall comply with the requirements of the Philippine Electrical Code and other local lightning protection standards.

c. Conductors, rods, grounding systems, and surge protection devices shall be appropriately designed and installed to minimize damage caused by lightning strikes.

Note: Above mentioned, if applicable or if included in the Program of Works and Plans.

10-09 TESTING AND COMMISSIONING

- a. All electrical systems and equipment shall undergo thorough testing and commissioning procedures to ensure compliance with design specifications and operational reliability.
- b. Comprehensive testing reports, records, and relevant certificates shall be prepared and provided for validation and future reference.

10-10 DOCUMENTATION AND AS-BUILT DRAWINGS

- a. As-built drawings, electrical schematics, and other documentation shall be efficiently recorded and organized, complying with the requirements of the project and local authorities.
- b. Operation and maintenance manuals for all electrical systems and equipment shall be prepared and handed over to the client upon project completion.

Note: These technical specifications should be customized further to adhere to specific project requirements, local regulations, and professional engineering recommendations in the Philippines.

11-00 PAINTING AND VARNISHING

11-01 SCOPE

The work covered by this part of the Specifications consists in furnishing all materials, labor, equipment's, tools and other necessary requirements in performing all operations for the painting and varnishing or finishing the building or structure in accordance with the contract.

11-02 MATERIALS

All paints wood stain and varnish materials shall meet the requirements of the Standard Specifications of the manufacturers. Paints shall be well ground, and shall show easy brushing properties, and shall be of such composition that it cannot be broken up easily with a paddle on a smooth consistency. Paint shall neither settle badly nor cake in the container.

11-03 EXTERIOR PAINTING

a. Concrete, stucco and masonry

After the required preparations, all exposed exterior surfaces of concrete, masonry, and mortar to be painted shall be given two (2) coats of an approved cement wash on hydraulic base paint similar and equal to "M. C.", "konocrex" containing not less than 56% of white Portland cement, its main constituent and the necessary amount of approved lime-proof and sun-proof mineral pigments ground with the other materials at the factory. An interval of at least 7 days of good drying weather between coats shall be observe, Use "BOYSEN" or approved equivalent.

b. Metal

After the required protective painting for metal has been applied and allowed to dry for at least 72 hours in good drying weather, exposed metal (exterior) surface to be painted shall be given 2 coats of the required colors of paints. An interval of at least 72 hours of good drying weather between coats shall be observed.

c. Wood

After the necessary preparation, all exposed wood surfaces to be painted, including the ceiling under awnings, shall be given 2 coats of the same paint, as that specified for metal surfaces, applied in the same manner, and with the same drying interval between coats.

11-04 INTERIOR PAINTING

a. Concrete, Masonry and Mortar

Interior concrete, masonry and mortar surfaces shall be given 2 coats of the same kind of paint, as that specified in paragraph "a" of Section 11-03 hereof, applied similarly, and with the same drying interval coats.

b. Metal and Wood

After the necessary preparations, interior surfaces of metal and wood to be painted, including the Composition ceiling boards, shall be given 2 coats of the required color of paints, and be applied in the same manner and with the same drying interval between coats as those specified for exterior metal and wood surfaces. Use "Boysen", "Dutch Boy" or approved equal.

11-05 STAINING AND VARNISHING

After the necessary preparation, all interior wood surfaces to be stained and varnished shall be given 2 coats of a mixture of varnished and stain of such color and such proportions as to be produce the required finish. Varnish shall consist of the best quality shall dissolved in alcohol.

12-00 FIRE PROTECTION

All interior wooden structures shall be treated with an approved quality of fire-retardant solution. All other requirements of the "Fire Prevention Code of the Philippines "(P.D.) 1185), insofar as they relate to the project shall likewise be satisfactorily complied with Bureau of Fire Protection (BFP).

B. GOODS TECHNICAL SPECIFICATIONS

1. 125 KVA Standby Diesel Power Generator

Standby Power	-	125 KVa/100 KW
Prime Power	-	114 KVa/91 KW
Voltage	-	220V/60Hz
Phase	-	3
Ampere	-	315 A
Power Factor	-	0.8
Noise Level	-	70 dba
Engine Speed	-	1800
Tank Cap	-	240 L

2. Laboratory Center Table with End Sink (3600L x 1000W x 900H)

Material:

1. size:3600*1200*750Hmm
2. cupboard material: High density 15mm MDF with Melamine board, Fireproofing, scratch-resistant, without contaminated
3. table top: The board is acid-resistant, alkali-resistant, scratch-resistant, extreme resistance to scratch & wear, radiant heat, high temperature, and impact, and easy to clean
4. with the water sink and outlet, acid-resistant, alkali-resistant, scratch-resistant



3. Smart Interactive Digital Whiteboard 75"

- a. Interactive Display, 65" IPS Display, 4K UHD Resolution, 8ms Response Time, IR Touch Technology, WiFi + Bluetooth Connectivity, 12/7 Operation Time, Black
- b. Manual Lifting Height Adjustable Ultra-Large Display TV Stand, For Most 60" - 100" Screen, Up to 100kg Weight Capacity, Material Steel, Aluminum, Plastic, Black



4. Teacher's Desk

Product Dimensions: 60 W x 30 D x 30 H in, 72 W x 30 D x 30 H in
Allergens: Contains No Allergens
Description: Double Pedestal Desk
Material Type: Laminate and Steel



5. Student Desk Chair

- Material - Bamboo & Steel
- Feature - Eco-Friendly, Durable, Sturdy And Practical
- Application - School, Classroom, Tutoring Office
- Structure Feature - High-Weight Capacity, Anti-Wobble Design
- Height Feature - Adjustable Height For Different Student Ages
- Surface Finish - Smooth, Easy-Clean, Scratch-Resistant
- Color Options - Customized Color Options Available



6. Office Table

- Study table, writing table, study table
- Free standing table with metal body
- 47.24"L x 23.62"W x 29.53"H
- 1200L x 600W x 750H mm
- color: beige or light gray



7. Swivel Chair

- Ergo dynamic LUXE PU Chair 360° Swivel Function Reclining Luxury High Back Office Chair
- DGM 903 silver armrest and 360 degrees' swivel function
- Pneumatic height adjustment
- B560 Simple Butterfly Mechanism – easy control for gas lift & tilt adjustment
- D100 Class 3 Gas Lift – reliable height adjustment for everyday use
- R350mm Nylon Silver Star base with 50mm Casters – sturdy base with smooth mobility
- Designed for Daily Use – ideal for 1 shift per day (up to 8 hours maximum)



Section VII. Drawings

Insert here a list of Drawings. The actual Drawings, including site plans, should be attached to this section or annexed in a separate folder.

TABLE OF CONTENTS	
ARCHITECTURAL	
A-1	PERPECTIVE
	VICINITY MAP
A-2	SITE DEVELOPMENT PLAN
	GROUND FLOOR PLAN
A-3	FRONT ELEVATION
	REAR ELEVATION
	RIGHT SIDE ELEVATION
	LEFT SIDE ELEVATION
A-3	ROOF PLAN
	CROSS SECTION
	LONGITUDINAL SECTION
	SCHEDULE OF DOORS AND WINDOWS
STRUCTURAL	
S-1	FOUNDATION PLAN
	SECOND FLOOR FRAMING PLAN
S-2	ROOF FRAMING PLAN
	SCHEDULE OF BEAMS AND ROOF BEAMS
S-3	DETAIL OF WALL FOOTING
	DETAIL OF COLUMN FOOTING
	TYPICAL DETAIL OF BEAM
	TYPICAL DETAIL OF TRUSS
	TYPICAL DETAIL OF TWO WAY SLAB
	TYPICAL DETAIL OF CANTILEVER BEAM
ELECTRICAL	
E-1	GROUND FLOOR LIGHTING LAYOUT
	SECOND FLOOR LIGHTING LAYOUT
E-2	GROUND FLOOR POWER LAYOUT
	SECOND FLOOR POWER LAYOUT
E-3	SCHEDULE OF LOADS
	RISER DIAGRAM
	PANEL DIAGRAM
	GENERAL ELECTRICAL NOTES
	LEGEND
PLUMBING	
P-1	GROUND FLOOR WATER LAYOUT
	SECOND FLOOR WATER LAYOUT
P-2	GROUND FLOOR SANITARY LAYOUT
	SECOND FLOOR SANITARY LAYOUT
P-3	GROUND FLOOR STORM DRAINAGE LAYOUT
	SECOND FLOOR STORM DRAINAGE LAYOUT
P-4	DETAIL OF SEPTIC TANK
	DETAIL OF CATCH BASIN
	ARRANGEMENT OF PIPES
	LEGEND
	GENERAL PLUMBING NOTES
	DETAIL OF DOWNPOUT CONNECTION
MECHANICAL	

REMARKS OF THE ENGINEER: DEPARTMENT OF PUBLIC WORKS AND HIGHWAYS OFFICE OF THE PALINGO OFFICIAL	REVISIONS	SHEET NO. A-1
DESIGNER / CITY / MUNICIPALITY	PERPECTIVE SITE DEVELOPMENT PLAN VICINITY MAP	
LAND USE AND ZONING		
LINE AND GRADE		
ARCHITECTURAL		
STRUCTURAL		
ELECTRICAL		
SANITARY		
ELECTRICAL		
MECHANICAL		



1 PERSPECTIVE VIEW

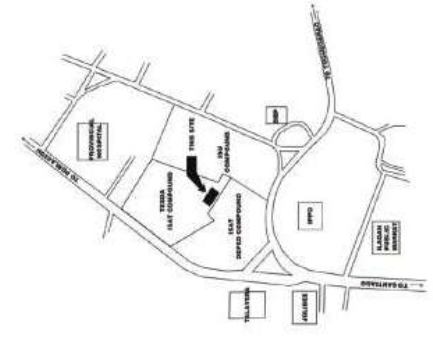

2 VICINITY MAP

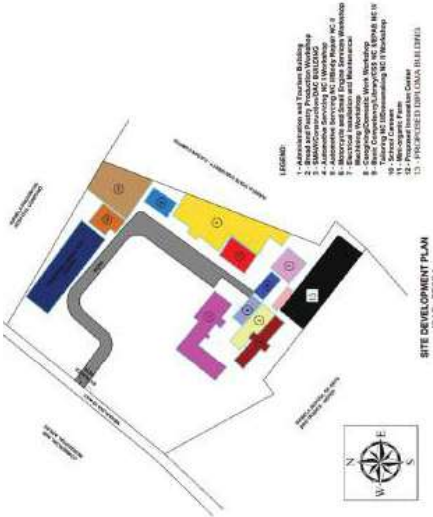

3 SITE DEVELOPMENT PLAN

 TESDA	 ISAT	PROJECT TITLE "PROPOSED 3 - STOREY POE LEVEL 5 (DIPLOMA) BUILDING"	OWNER	TESDA - ISAT	RECOMMENDING APPROVAL M. E. NARCISO ACTING VOCATIONAL SCHOOL SUPERINTENDENT	APPROVED BY ASHARY A. BANTJO, JR., CESE REGIONAL DIRECTOR	SHEET CONTENTS: PERPECTIVE SITE DEVELOPMENT PLAN VICINITY MAP	REVISIONS	SHEET NO. A-1
		LOCATION: TESDABAY, CALAWAGUI, CITY OF LAGAN, ISABELA	ADDRESS: TESDABAY, CALAWAGUI, CITY OF LAGAN, ISABELA						

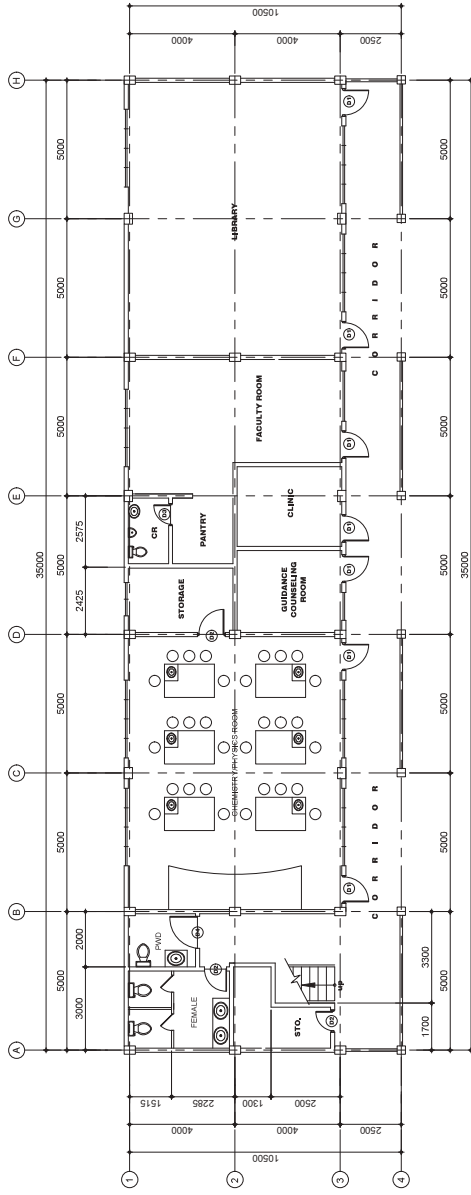

GROUND FLOOR PLAN

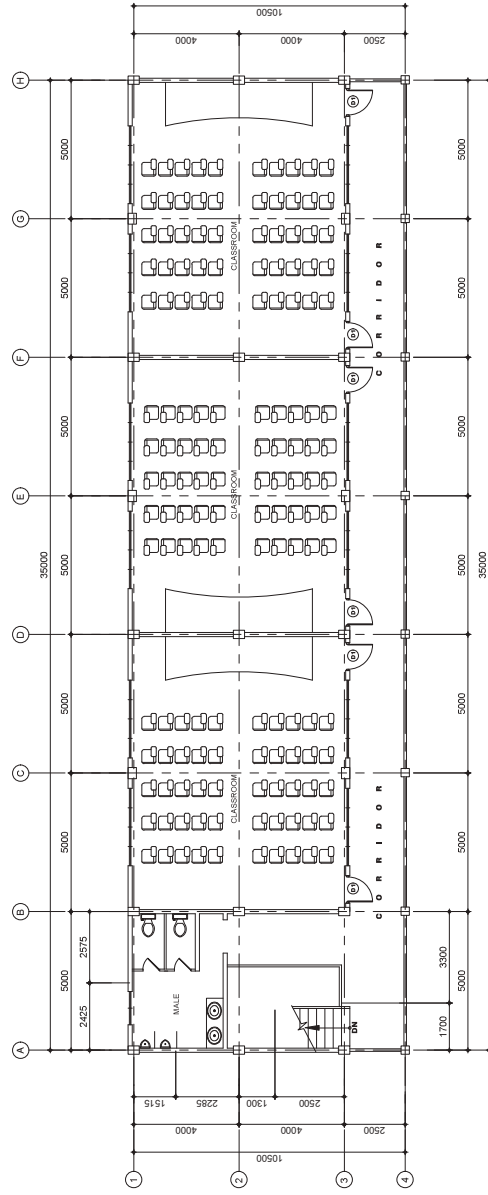

TYPICAL 2ND AND 3RD FLOOR PLAN

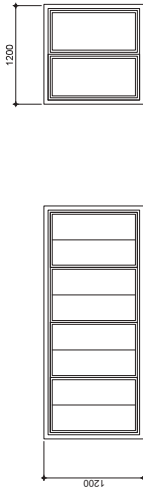

SCHEDULE OF DOORS AND WINDOWS



PROJECT TITLE: "PROPOSED 3 - STOREY POE LEVEL 5 (DIPLOMA) BUILDING"
 LOCATION: TESDA-BAY, CALAMAGUI, CITY OF LAGAN, BABELA

OWNER: TESDA - ISAT
 ADDRESS: TESDA-BAY, CALAMAGUI, CITY OF LAGAN, BABELA

RECOMMENDING APPROVAL: M. ELENA M. NARCISO
 ACTING VOCATIONAL SCHOOL SUPERINTENDENT

APPROVED BY: ASHARY A. BANTO, JD, CESE
 REGIONAL DIRECTOR

SHEET CONTENTS:
 GROUND FLOOR
 SCHEDULE OF DOORS AND WINDOWS

REVISIONS:

SHEET NO. A-2

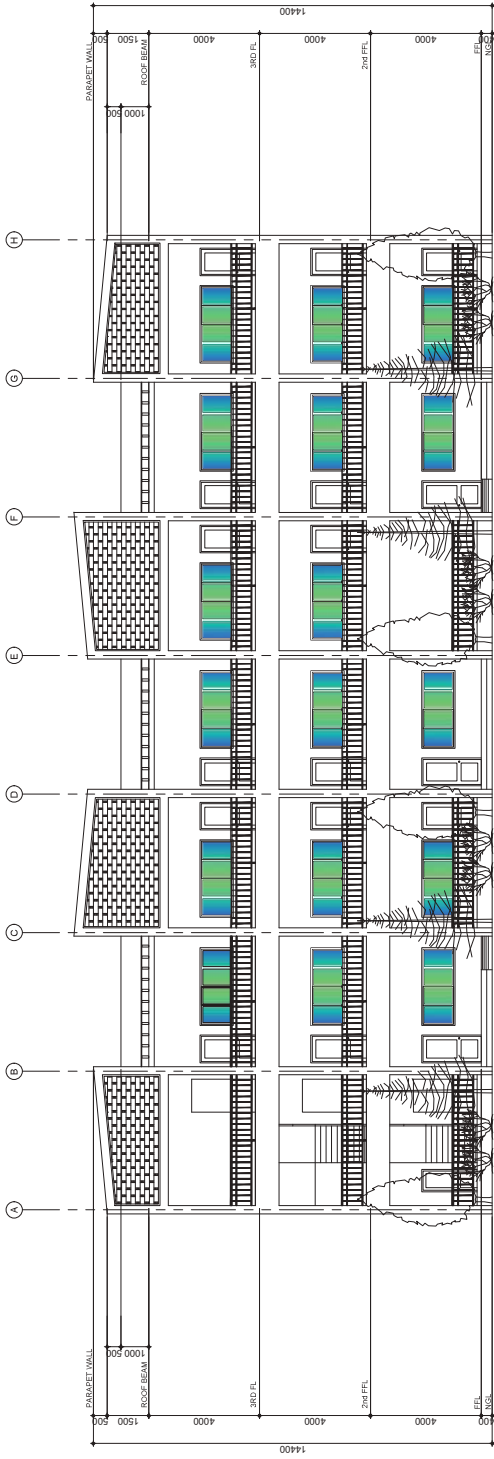

FRONT ELEVATION

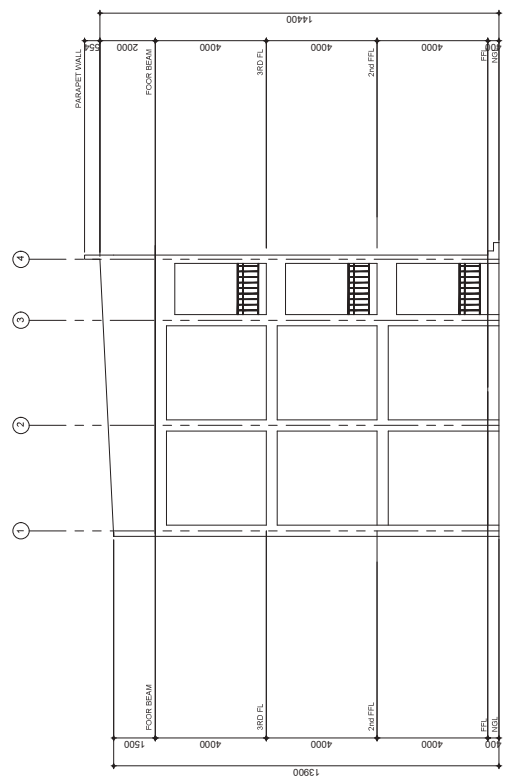

SIDE ELEVATION



PROJECT TITLE
 "PROPOSED 3 - STOREY POE LEVEL 5 (DIPLOMA) BUILDING"
 LOCATION: TESDABAY, CALAMAGUI, CITY OF LAGAN, BABELA

OWNER
 TESDA - ISAT
 ADDRESS: TESDABAY, CALAMAGUI, CITY OF LAGAN, BABELA

RECOMMENDING APPROVAL

 MR. ELMER NARCISO
 ACTING VOCATIONAL SCHOOL SUPERINTENDENT

APPROVED BY

 ASHARY A. BANTJO, JR. CESE
 REGIONAL DIRECTOR

SHEET CONTENTS:
 FRONT ELEVATION
 SIDE ELEVATION

NO.	REVISIONS

SHEET NO.
 A - 3

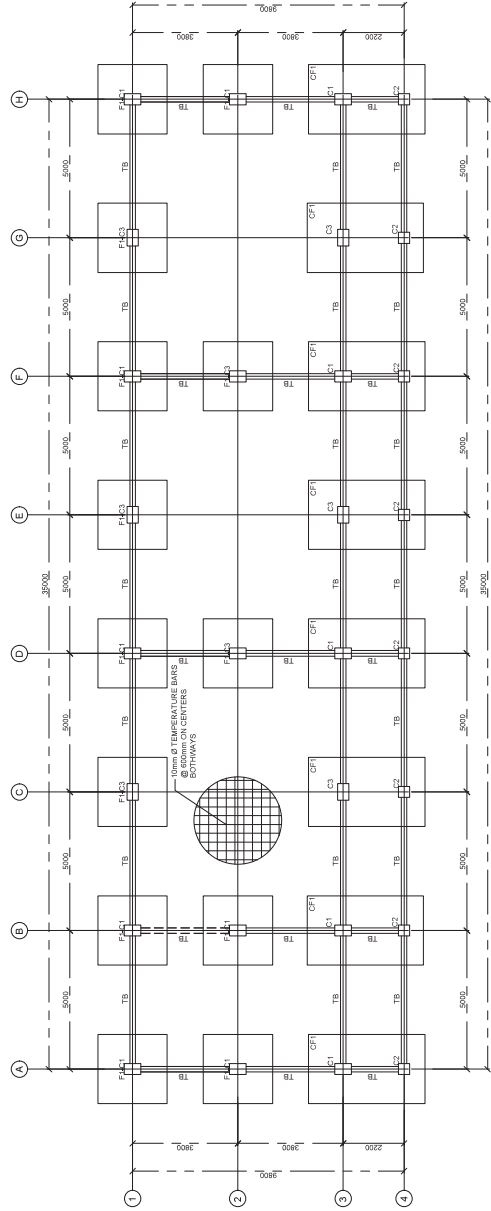

1 FOUNDATION PLAN

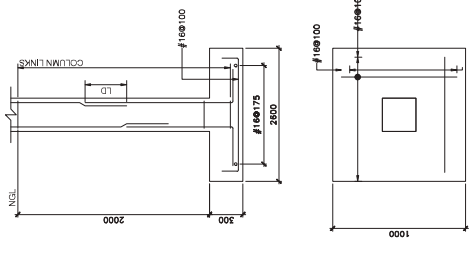

3 F2-C2 DETAIL

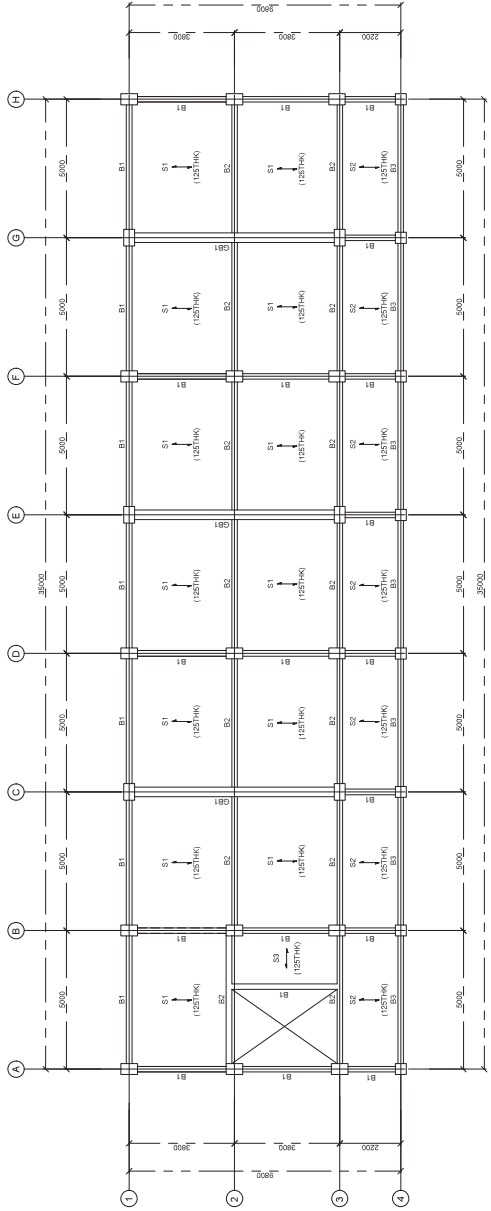

2 2ND AND 3RD FLOOR FRAMING PLAN

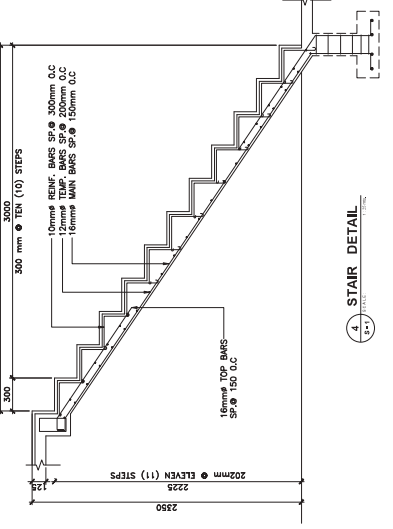

4 STAIR DETAIL



PROJECT TITLE
 "PROPOSED 3 - STOREY POE LEVEL 5 (DIPLOMA) BUILDING"
 LOCATION: TESDABAY, CALABAGUI, CITY OF LAGAN, BARCELONA

OWNER
 TESDA - ISAT
 ADDRESS: TESDABAY, CALABAGUI, CITY OF LAGAN, BARCELONA

RECOMMENDING APPROVAL

 M. ELENA A. NARCISO
 ACTING VOCATIONAL SCHOOL SUPERINTENDENT





APPROVED BY

 ASHARY A. BANTO, JR. CESE
 REGIONAL DIRECTOR

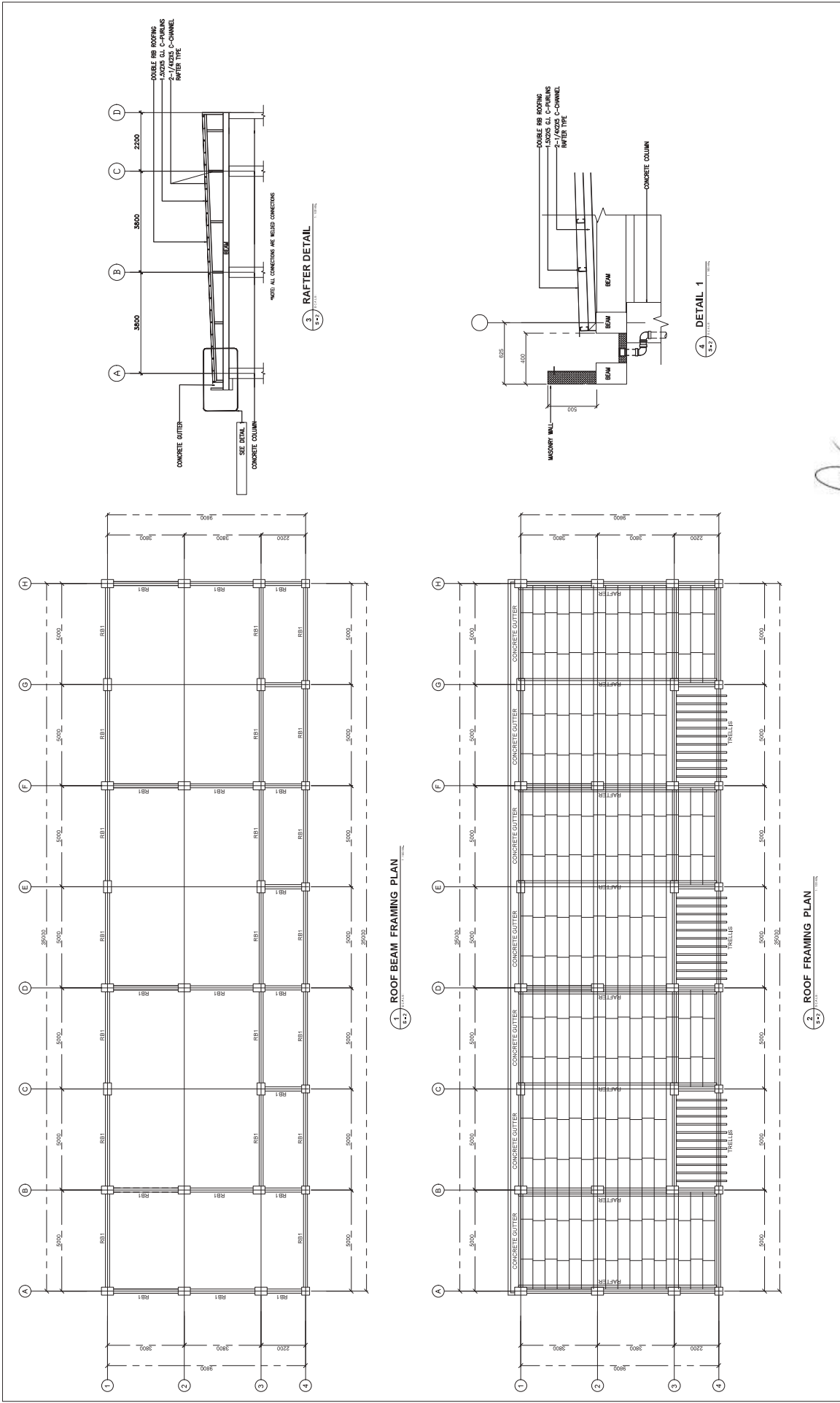
SHEET CONTENTS:
 FOUNDATION PLAN
 2ND AND 3RD FLOOR FRAMING LAYOUT
 F2-C2 DETAIL
 STAIR DETAIL

REVISIONS:
 SHEET NO.
 S-1



 	PROJECT TITLE "PROPOSED 3 - STOREY POF LEVEL 5 (DIPLOMA) BUILDING"	OWNER TESDA - ISAT	RECOMMENDING APPROVAL  M. ELMER NARCISO ACTING VOCATIONAL SCHOOL SUPERINTENDENT	APPROVED BY  ASHARY A. BANTOL, JD, CESE REGIONAL DIRECTOR	SHEET CONTENTS: ROOF BEAM FRAMING PLAN ROOF FRAMING PLAN RAFTER DETAIL	REVISIONS <table border="1"> <tr><td> </td><td> </td></tr> <tr><td> </td><td> </td></tr> <tr><td> </td><td> </td></tr> </table>							SHEET NO. S - 2
LOCATION: TESDABAY, CALAMAGUI, CITY OF LAGAN, IBALELA	ADDRESS: TESDABAY, CALAMAGUI, CITY OF LAGAN, IBALELA	TESDA - ISAT	ISAT										

10.1M	 6MM COVER - 50MM CONFINEMENT ZONE - 50MM	 6MM COVER - 50MM CONFINEMENT ZONE - 50MM	 6MM COVER - 50MM CONFINEMENT ZONE - 50MM
TO	Z1 MAIN LINK Z1 OTHERS #10 @ 150 #10 @ 150	Z1 MAIN LINK Z1 OTHERS #10 @ 150 #10 @ 150	Z1 MAIN LINK Z1 OTHERS #10 @ 150 #10 @ 150
10.4M	 6MM COVER - 50MM CONFINEMENT ZONE - 50MM	 6MM COVER - 50MM CONFINEMENT ZONE - 50MM	 6MM COVER - 50MM CONFINEMENT ZONE - 50MM
TO	Z1 MAIN LINK Z1 OTHERS #10 @ 150 #10 @ 150	Z1 MAIN LINK Z1 OTHERS #10 @ 150 #10 @ 150	Z1 MAIN LINK Z1 OTHERS #10 @ 150 #10 @ 150
6.5M	 6MM COVER - 50MM CONFINEMENT ZONE - 50MM	 6MM COVER - 50MM CONFINEMENT ZONE - 50MM	 6MM COVER - 50MM CONFINEMENT ZONE - 50MM
TO	Z1 MAIN LINK Z1 OTHERS #10 @ 150 #10 @ 150	Z1 MAIN LINK Z1 OTHERS #10 @ 150 #10 @ 150	Z1 MAIN LINK Z1 OTHERS #10 @ 150 #10 @ 150
10.1M	 6MM COVER - 50MM CONFINEMENT ZONE - 50MM	 6MM COVER - 50MM CONFINEMENT ZONE - 50MM	 6MM COVER - 50MM CONFINEMENT ZONE - 50MM
TO	Z1 MAIN LINK Z1 OTHERS #10 @ 150 #10 @ 150	Z1 MAIN LINK Z1 OTHERS #10 @ 150 #10 @ 150	Z1 MAIN LINK Z1 OTHERS #10 @ 150 #10 @ 150
2.5M	 6MM COVER - 50MM CONFINEMENT ZONE - 50MM	 6MM COVER - 50MM CONFINEMENT ZONE - 50MM	 6MM COVER - 50MM CONFINEMENT ZONE - 50MM
TO	Z1 MAIN LINK Z1 OTHERS #10 @ 150 #10 @ 150	Z1 MAIN LINK Z1 OTHERS #10 @ 150 #10 @ 150	Z1 MAIN LINK Z1 OTHERS #10 @ 150 #10 @ 150
6.5M	 6MM COVER - 50MM CONFINEMENT ZONE - 50MM	 6MM COVER - 50MM CONFINEMENT ZONE - 50MM	 6MM COVER - 50MM CONFINEMENT ZONE - 50MM
TO	Z1 MAIN LINK Z1 OTHERS #10 @ 150 #10 @ 150	Z1 MAIN LINK Z1 OTHERS #10 @ 150 #10 @ 150	Z1 MAIN LINK Z1 OTHERS #10 @ 150 #10 @ 150
0M	 6MM COVER - 50MM CONFINEMENT ZONE - 50MM	 6MM COVER - 50MM CONFINEMENT ZONE - 50MM	 6MM COVER - 50MM CONFINEMENT ZONE - 50MM
TO	Z1 MAIN LINK Z1 OTHERS #10 @ 150 #10 @ 150	Z1 MAIN LINK Z1 OTHERS #10 @ 150 #10 @ 150	Z1 MAIN LINK Z1 OTHERS #10 @ 150 #10 @ 150
2.5M	 6MM COVER - 50MM CONFINEMENT ZONE - 50MM	 6MM COVER - 50MM CONFINEMENT ZONE - 50MM	 6MM COVER - 50MM CONFINEMENT ZONE - 50MM
TO	Z1 MAIN LINK Z1 OTHERS #10 @ 150 #10 @ 150	Z1 MAIN LINK Z1 OTHERS #10 @ 150 #10 @ 150	Z1 MAIN LINK Z1 OTHERS #10 @ 150 #10 @ 150
COLUMN MARKED	C1	C2	C3

RC COLUMN SCHEDULE

NOTES:
 1. RE - BOUNDARY ELEMENT AS PER A.C.I. 318M, PROVIDE CONTINUING REINFORCEMENT ABOVE ENTIRE HEIGHT OF WALL IN BOUNDARY ELEMENT
 2. Z1 - SPECIAL CONFINEMENT ZONE AS PER A.C.I. 318M Z2 - REMAINING ZONE AS PER A.C.I. 318M

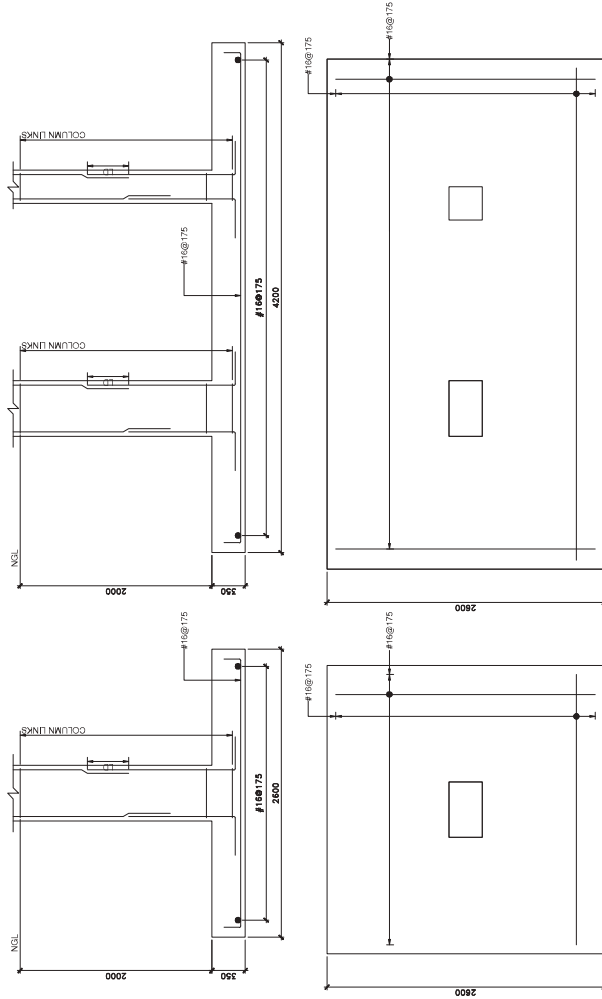

3 FIC1 DETAIL

4 FIC1 DETAIL

SLAB SCHEDULE (C20 : FY275) (LEVEL : 5.6M)

SLAB MARKED	SLAB THICKNESS	BOTTOM REINFORCEMENT		TOP REINFORCEMENT			REMARKS
		ALONG SHORT SPAN	ALONG LONG SPAN	OVER LONG SUPPORT	OVER SHORT SUPPORT	DISTRIBUTION	
S1	125	#10 @ 150 CC	#10 @ 150 CC	CONTINUOUS SUPPORT	CONTINUOUS SUPPORT	#10 @ 150 CC	---
S2	125	#10 @ 175 CC	#10 @ 175 CC	---	---	#10 @ 175 CC	---
S3	125	#10 @ 200 CC	#10 @ 200 CC	---	---	#10 @ 200 CC	---

RC SLAB SCHEDULE



PROJECT TITLE:
"PROPOSED 3 - STOREY PQF LEVEL 5 (DIPLOMA) BUILDING"

LOCATION: TESDAHAY, CALAMAGUI, CITY OF LAGUNA, BABELA

OWNER:
TESDA - ISAT

ADDRESS: TESDAHAY, CALAMAGUI, CITY OF LAGUNA, BABELA

RECOMMENDING APPROVAL:

MA. ELEAZAR NARCISO
 ACTING VOCATIONAL SCHOOL SUPERINTENDENT

APPROVED BY:

ASHARY A. BANTO, JR.
 REGIONAL DIRECTOR

SHEET CONTENTS:
 RC COLUMN SCHEDULE
 RC SLAB SCHEDULE
 FIC1 DETAIL

REVISIONS:

SHEET NO. **03**

BEAM SCHEDULE

BEAM NUMBERS	SIZE		BOTTOM REINFORCEMENT			TOP REINFORCEMENT			SHEAR STIRRUPS	SFR	DIAGONAL	REMARKS
	B	D	LEFT	MID SPAN	RIGHT	LEFT	MID SPAN	RIGHT				
TB	250	350	3-#16	3-#16	3-#16	3-#16	3-#16	3-#16	#10 - @60, @75, 5#100 AND REST 200 O.C	2-#16EF	-	-
GB1	300	700	3-#20	3-#20	3-#20	3-#20	3-#20	3-#20	#10 - @60, @75, 5#100 AND REST 200 O.C	-	-	-
B1	250	500	3-#20	3-#20	3-#20	3-#20	3-#20	3-#20	#10 - @60, @75, 5#100 AND REST 200 O.C	-	-	-
B2	250	500	3-#20	3-#20	3-#20	3-#20	3-#20	3-#20	#10 - @60, @75, 5#100 AND REST 200 O.C	2-#16EF	-	-
B3	250	400	3-#16	3-#16	3-#16	3-#16	3-#16	3-#16	#10 - @60, @75, 5#100 AND REST 200 O.C	-	-	-
RB	250	400	3-#16	3-#16	3-#16	3-#16	3-#16	3-#16	#10 - @60, @75, 5#100 AND REST 200 O.C	-	-	-
CB	250	400	3-#16	3-#16	3-#16	3-#16	3-#16	3-#16	#10 - @60, @75, 5#100 AND REST 200 O.C	-	-	-

RC BEAM SCHEDULE

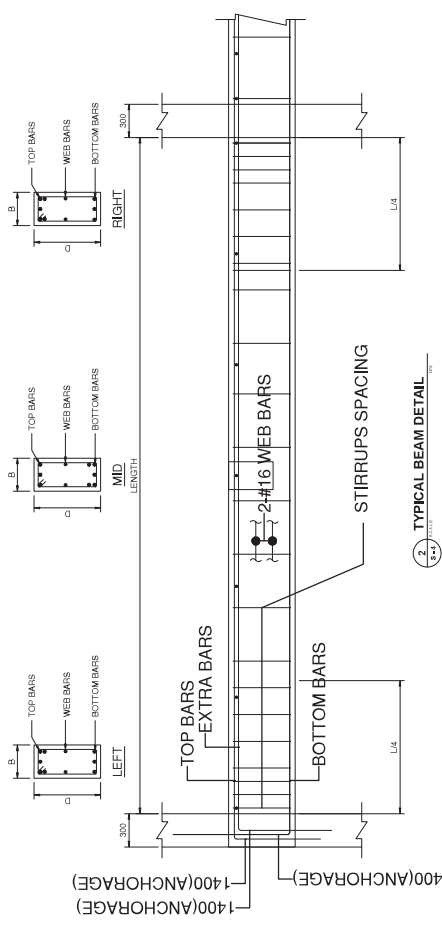
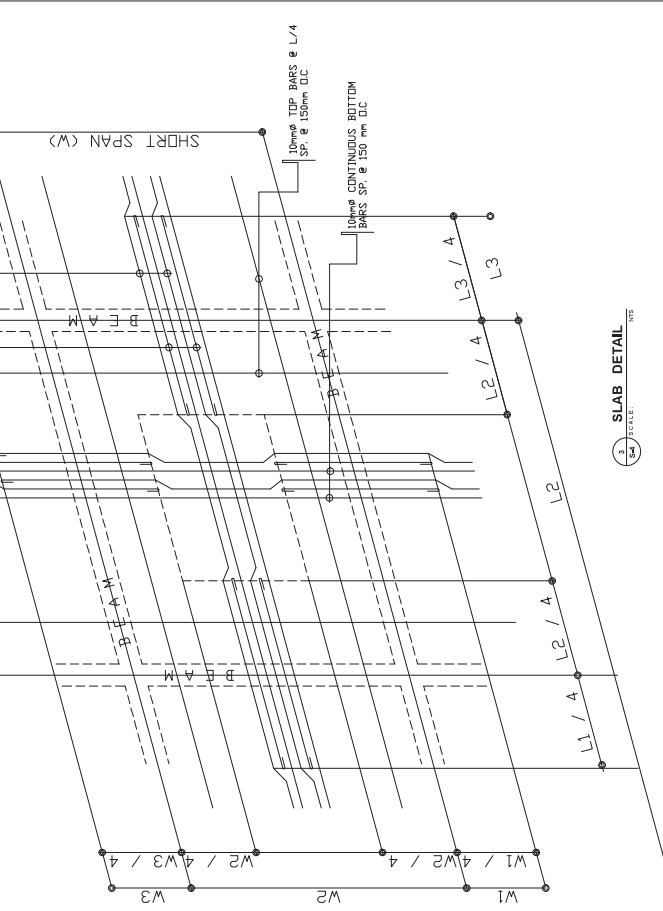

PROJECT TITLE: "PROPOSED 3 - STOREY PQF LEVEL 5 (DIPLOMA) BUILDING"
 LOCATION: TESDABAY, CALAMAGUI, CITY OF LAGUNA, BABELA

OWNER: TESDA - ISAT
 ADDRESS: TESDABAY, CALAMAGUI, CITY OF LAGUNA, BABELA

RECOMMENDING APPROVAL:

 MA. ELENA P. NARCISO
 ACTING VOCATIONAL SCHOOLS SUPERINTENDENT

APPROVED BY:

 ASHARY A. BANTO, JR. CESE
 REGIONAL DIRECTOR

SHEET CONTENTS:
 RC BEAM SCHEDULE
 TYPICAL BEAM
 SLAB DETAIL

REVISIONS:
 SHEET NO. S-4

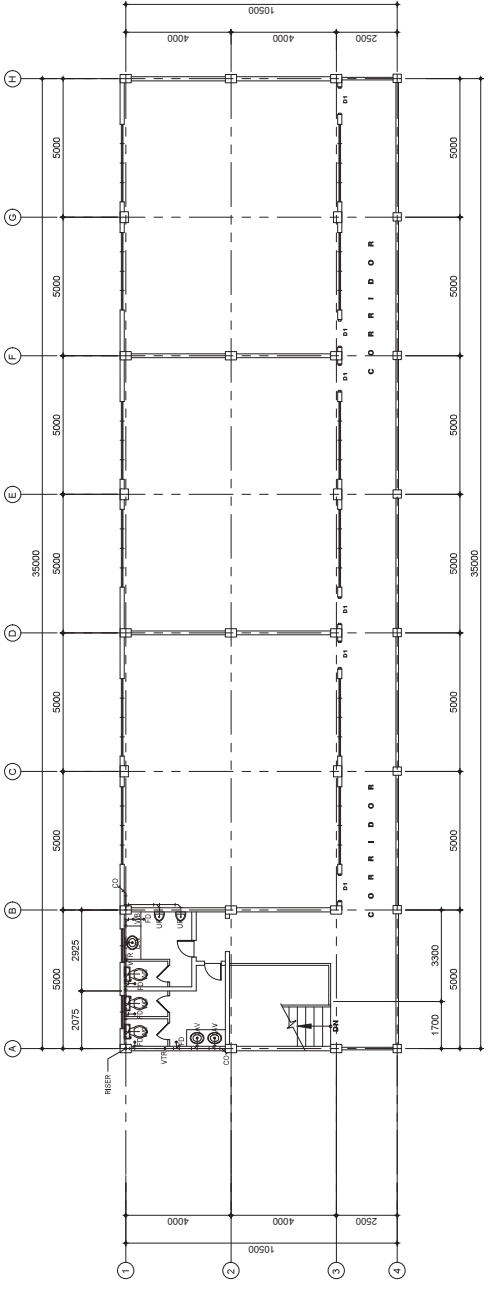
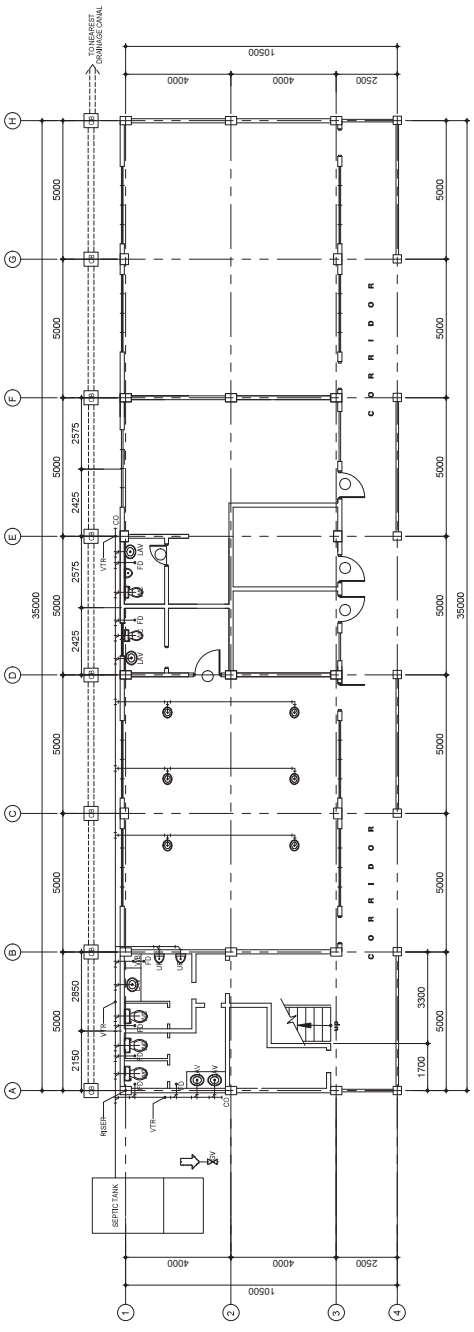

PROJECT TITLE
 "PROPOSED 3 - STOREY PQF LEVEL 5 (DIPLOMA) BUILDING"
 LOCATION: TESDABAY, CALAMAGUI, CITY OF LAGAN, IBALELA

OWNER
TESDA - ISAT
 ADDRESS: TESDABAY, CALAMAGUI, CITY OF LAGAN, IBALELA

RECOMMENDING APPROVAL

M. ELEANORA ARCISO
 ACTING VOCATIONAL SCHOOL SUPERINTENDENT

APPROVED BY

ASHARY A. BANTJO, JR. CESE
 REGIONAL DIRECTOR

SHEET CONTENTS:
 GROUND PLUMBING LAYOUT
 2ND AND 3RD FLOOR PLUMBING LAYOUT

REVISED	REVISIONS

SHEET NO.
P - 1

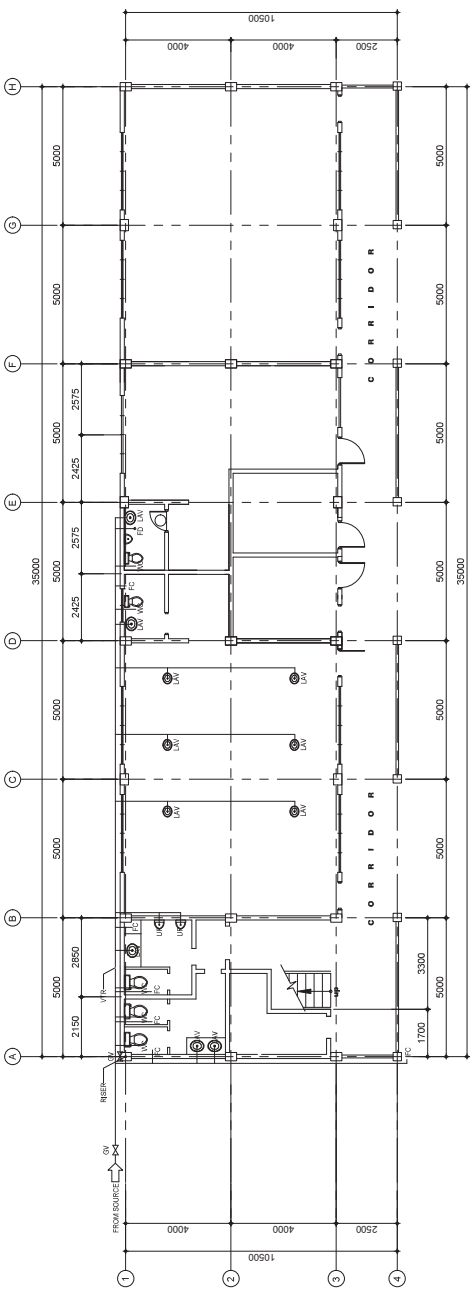

1 GROUND FLOOR WATER LAYOUT

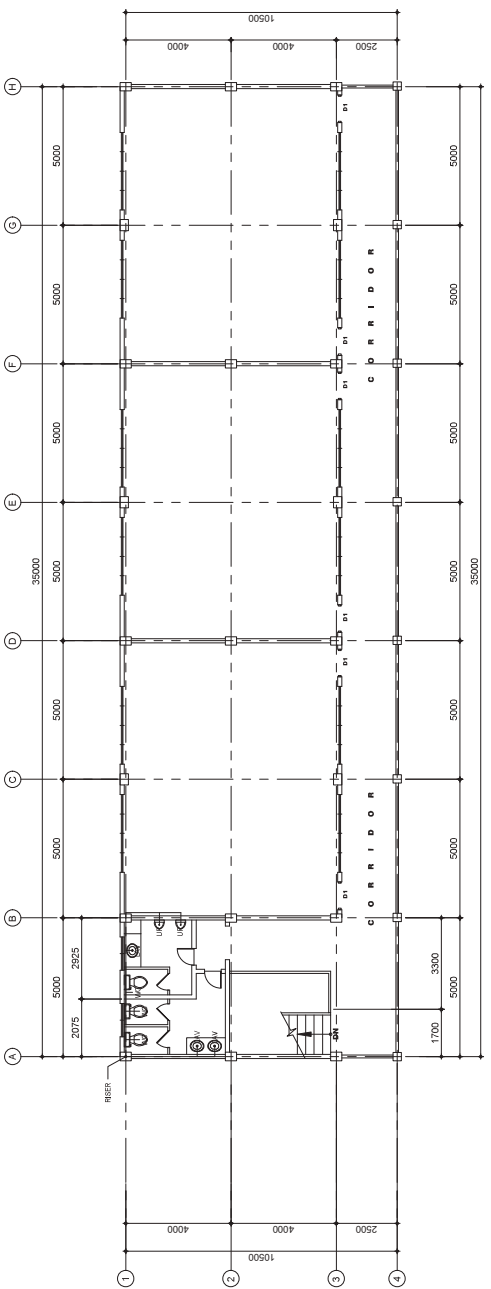

2 TYPICAL 2ND AND 3RD FLOOR WATER LAYOUT

 	PROJECT TITLE "PROPOSED 3 - STOREY PQF LEVEL 5 (DIPLOMA) BUILDING"	OWNER TESDA - ISAT	ADDRESS: TESDABAY, CALAMAGUI, CITY OF LAGAN, IBBABELA	RECOMMENDING APPROVAL  M. ELEAZAR NARCISO ACTING VOCATIONAL SCHOOL SUPERINTENDENT	APPROVED BY  ASHARY A. BANTJO, JR. CESE REGIONAL DIRECTOR	SHEET CONTENTS: GROUND WATER LAYOUT 2ND AND 3RD FLOOR WATER LAYOUT	REVISIONS <table border="1"> <tr><td> </td><td> </td></tr> <tr><td> </td><td> </td></tr> <tr><td> </td><td> </td></tr> <tr><td> </td><td> </td></tr> </table>									SHEET NO. 

GENERAL PLUMBING NOTES

- Grade of all horizontal piping runs all horizontal in perfect alignment at from grade or not less than 2%.
- Change in Direction: All change in direction shall be made of approximate use of 45 degrees Wyes, Long Sweep Quarter Bend, 6/8 or Sixteenth Bends. When change of flow is from horizontal or vertical, a single 1/8 Bend combination maybe used on Vertical Stack, and short Quarter Bends maybe used in Vent Pipes.
- Prohibited from No Double Hub or Tee Branch shall be used on Horizontal Soil or Waste Line, the drillings and tapping of house drain, Waste or Vent Pipes, and use of Saddle Hub and Bends are prohibited.
- Pipe Clean-Outs, Clean-Outs are required under the following conditions:
 - Every change in horizontal direction exceeding 22.1/2 degrees.
 - 1.5 meters inside the property line before the House Drain connection.
 - Every 15 meters of direction run of pipes.
 - At the end of any horizontal pipelines.
- The Digestion Chamber of Septic Vault must be waterproofed.
- Not less than 0.30m air space must be left between the top of Sewage, and the under part of the vault roof slab.
- No Septic Vault shall be constructed inside the building.
- All Plumbing Works shall be done by a Licensed Master Plumber, or a Licensed Plumbing Contractor.

LEGEND	
KS	KITCHEN SINK
LAV	LAVATORY
FD	FLOOR DRAIN
CO	CLEAN OUT
FC	FAUCET
SHO	SHOWER
S	SINK
VC	WATER CLOSET
VSTR	VERTICAL STACK
RISER	
DS	DOWN SPOUT

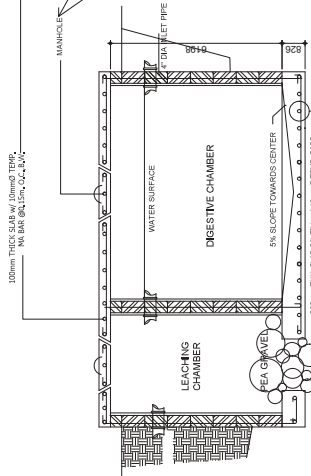
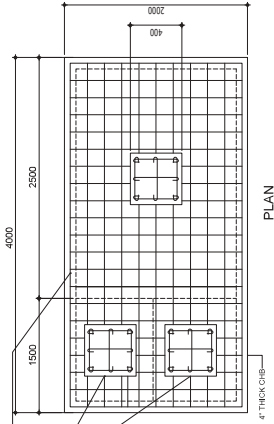

SECTION

1. DETAIL OF SEPTIC TANK

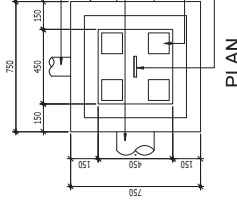

PLAN

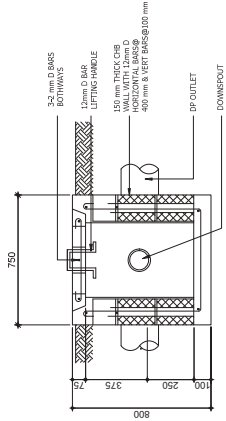

SECTION

4. DETAIL OF CATCH BASIN

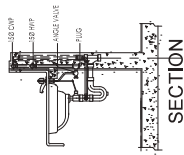

SECTION

2. DETAIL OF LAVATORY

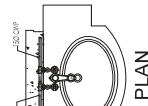

PLAN

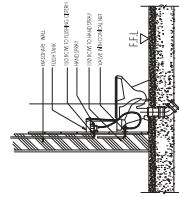

3. DETAIL OF WATER CLOSET

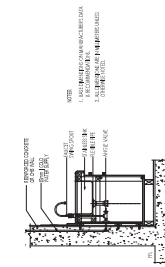

5. DETAIL OF CLEAN OUT

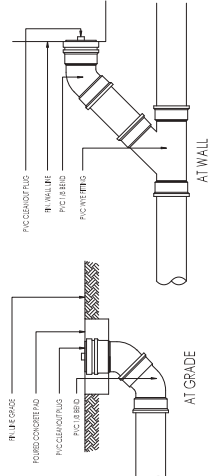

SECTION



PROJECT TITLE: "PROPOSED 3 - STOREY PQF LEVEL 5 (DIPLOMA) BUILDING"
 LOCATION: TESDABAY, CALAWAGUI, CITY OF LAGAN, ISABELA

OWNER: TESDA - ISAT
 ADDRESS: TESDABAY, CALAWAGUI, CITY OF LAGAN, ISABELA

RECOMMENDATION APPROVAL: M. ELEAZAR MARCOSO, ACTING VOCATIONAL SCHOOL SUPERINTENDENT

APPROVED BY: ASHARY A. BANTO, JR., CESE, REGIONAL DIRECTOR

SHEET CONTENTS: SEPTIC TANK DETAILS, DETAIL OF LAVATORY, DETAIL OF CATCH BASIN, DETAIL OF CLEAN OUT



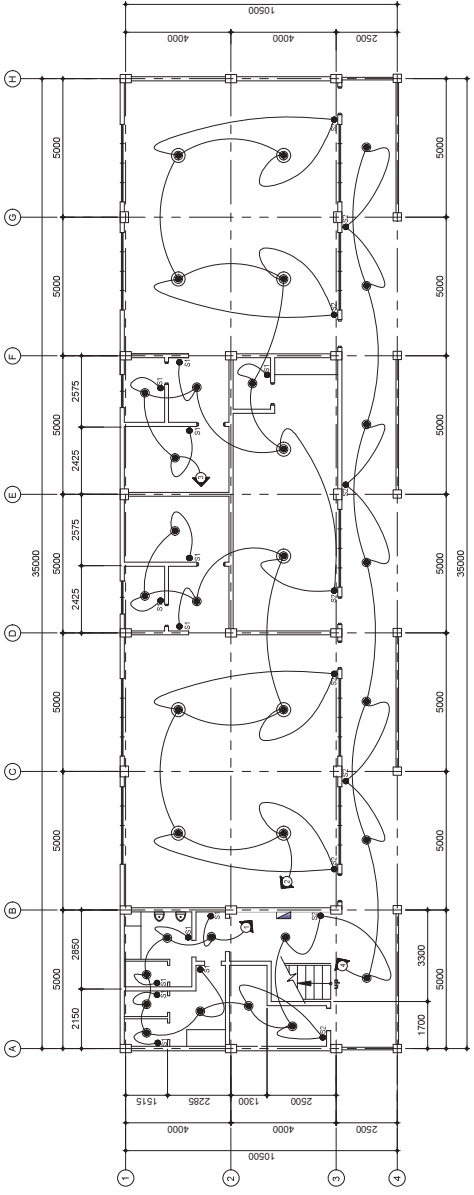

SHEET NO.: P-3

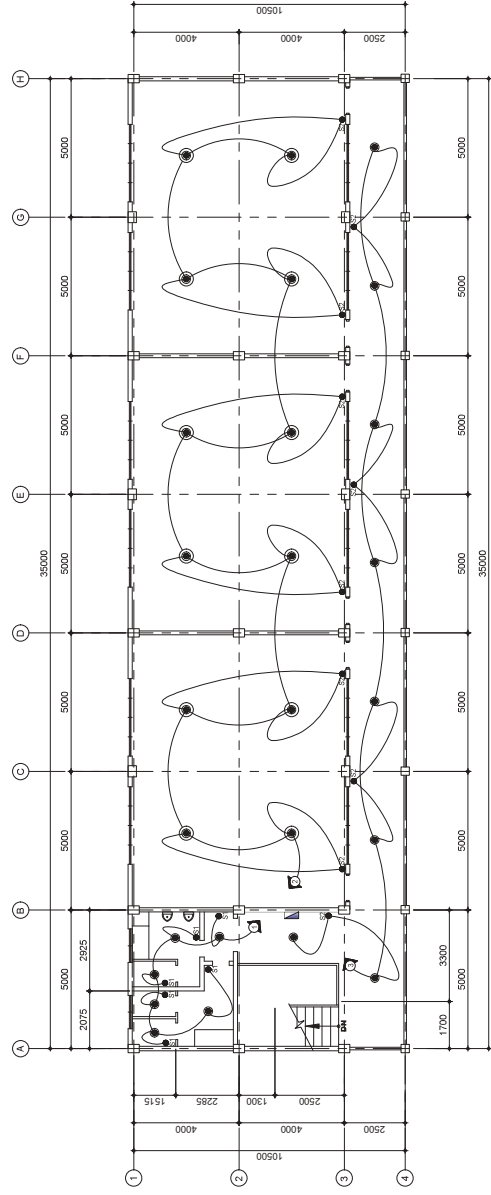

1. GROUND FLOOR LIGHTING LAYOUT



2. TYPICAL 2ND AND 3RD FLOOR LIGHTING LAYOUT

 	PROJECT TITLE "PROPOSED 3 - STOREY POE LEVEL 5 (DIPLOMA) BUILDING"	OWNER TESDA - ISAT	RECOMMENDING APPROVAL  M. ELMER NARCISO ACTING VOCATIONAL SCHOOL SUPERINTENDENT	APPROVED BY  ASHARY A. BANTOG, JR. CESE REGIONAL DIRECTOR	SHEET CONTENTS: GROUND FLOOR LIGHTING LAYOUT 2ND AND 3RD FLOOR LIGHTING LAYOUT	REVIEWS: <table border="1"> <tr><td> </td></tr> <tr><td> </td></tr> <tr><td> </td></tr> <tr><td> </td></tr> </table>					SHEET NO. 
LOCATION: TESDABAY, CALAMAGUI, CITY OF LAGAN, ISABELA	ADDRESS: TESDABAY, CALAMAGUI, CITY OF LAGAN, ISABELA										

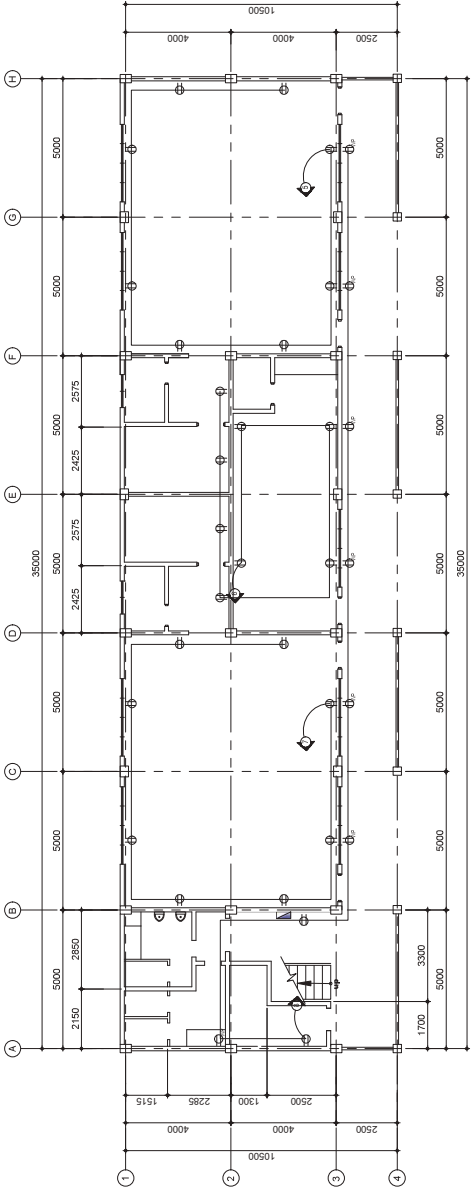

1 GROUND FLOOR LIGHTING LAYOUT

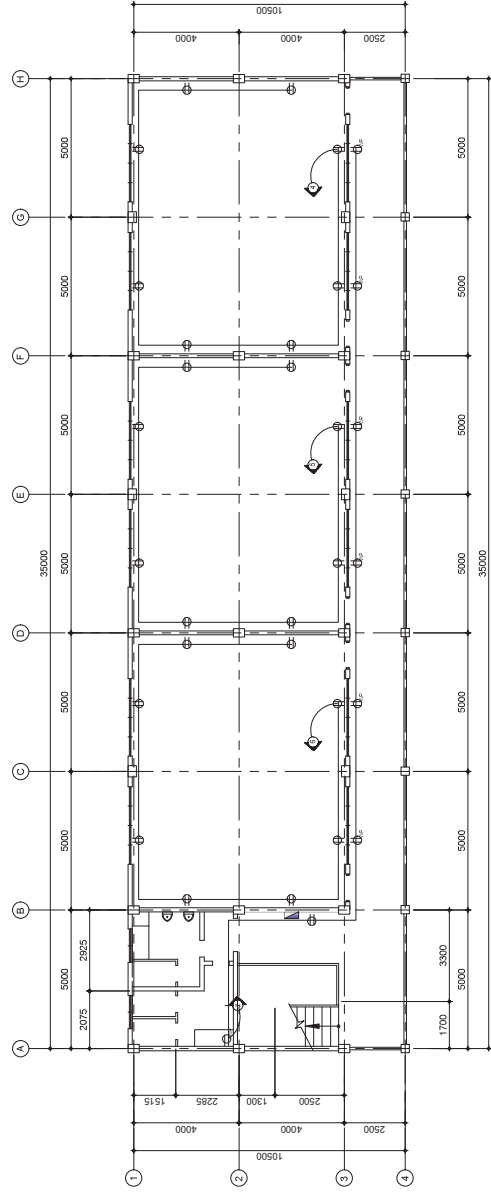

2 TYPICAL 2ND AND 3RD FLOOR LIGHTING LAYOUT

 	PROJECT TITLE "PROPOSED 3 - STOREY PQF LEVEL 5 (DIPLOMA) BUILDING"	OWNER TESDA - ISAT	LOCATION: TESDABAY, CALAMAGUI, CITY OF LAGAN, IBBABELA
	RECOMMENDING APPROVAL  M. ELEAZAR NARCISO ACTING VOCATIONAL SCHOOL SUPERINTENDENT	APPROVED BY  ASHARY A. BANTO, JD, CESE REGIONAL DIRECTOR	SHEET CONTENTS: GROUND FLOOR POWER LAYOUT 2ND AND 3RD FLOOR POWER LAYOUT
REVIEWS:			

SCHEDULE OF LOADS OF PB1

CKT NO.	LOAD DESCRIPTION	VOLTS	VA PER CIRCUIT	AMP. LOAD PER CIRCUIT	AT	SIZE OF HOME RUN
1	9 - LIGHTING OUTLET	220	900	4.1 AMP	15 AMP	3-3.5mm ² THHN WIRE
2	8 - LIGHTING OUTLET	220	800	3.6 AMP	15 AMP	3-3.5mm ² THHN WIRE
3	9 - LIGHTING OUTLET	220	900	4.1 AMP	15 AMP	3-3.5mm ² THHN WIRE
4	7 - LIGHTING OUTLET	220	700	3.2 AMP	15 AMP	3-3.5mm ² THHN WIRE
5	8 - CONV. OUTLET	220	1600	7.3 AMP	20 AMP	3-5.5mm ² THHN WIRE
6	8 - CONV. OUTLET	220	1600	7.3 AMP	20 AMP	3-5.5mm ² THHN WIRE
7	8 - CONV. OUTLET	220	1600	7.3 AMP	20 AMP	3-5.5mm ² THHN WIRE
8	9 - CONV. OUTLET	220	1800	8.2 AMP	20 AMP	3-5.5mm ² THHN WIRE
9	SPARE	220	3000	13.6 AMP	40 AMP	2-8.0mm ² THHN WIRE
10	SPARE	220	3000	13.6 AMP	40 AMP	2-8.0mm ² THHN WIRE

SCHEDULE OF LOADS OF PB23

CKT NO.	LOAD DESCRIPTION	VOLTS	VA PER CIRCUIT	AMP. LOAD PER CIRCUIT	AT	SIZE OF HOME RUN
1	6 - LIGHTING OUTLET	220	600	4.1 AMP	15 AMP	2-3.5mm ² THHN WIRE
2	15 - LIGHTING OUTLET	220	800	3.6 AMP	15 AMP	2-3.5mm ² THHN WIRE
3	7 - LIGHTING OUTLET	220	900	4.1 AMP	15 AMP	2-3.5mm ² THHN WIRE
4	8 - CONV. OUTLET	220	1600	7.3 AMP	20 AMP	2-5.5mm ² THHN WIRE
5	8 - CONV. OUTLET	220	1600	7.3 AMP	20 AMP	2-5.5mm ² THHN WIRE
6	8 - CONV. OUTLET	220	1600	7.3 AMP	20 AMP	2-5.5mm ² THHN WIRE
7	7 - CONV. OUTLET	220	1400	7.3 AMP	20 AMP	2-5.5mm ² THHN WIRE
8	SPARE	220	3000	13.6 AMP	40 AMP	2-8.0mm ² THHN WIRE
9	SPARE	220	3000	13.6 AMP	40 AMP	2-8.0mm ² THHN WIRE

SCHEDULE OF LOADS OF MDP

CKT NO.	LOAD DESCRIPTION	VOLTS	VA PER CIRCUIT	AMP. LOAD PER CIRCUIT	AT	SIZE OF HOME RUN
1	PB1	220				
2	PB2	220				
3	PB3	220				

ELECTRICAL NOTES

- ALL ELECTRICAL INSTALLATION WORKS SHALL BE DONE WITH THE ACCORDANCE WITH THE RULES AND REGULATIONS, THE APPROVALS PROVIDED BY THE LATEST EDITION OF APPLICABLE ELECTRICAL CODES, THE RULES AND REGULATIONS OF THE NATIONAL ELECTRICAL CONTRACTORS ASSOCIATION (NECA), THE NATIONAL ELECTRICAL SUPPLYING AND CONTRACTING COMPANY, THE ELECTRICAL WORKS SHALL BE UNDER THE SUPERVISION OF A DULY LICENSED ELECTRICAL ENGINEER.
- UTILITY VOLTAGE TO THE UNIT SHALL BE SINGLE PHASE 1 WIRE 220V 60HZ.
- THE ELECTRICAL WIRING INSTALLATION SHALL BE DONE IN INTERMEDIATE METALLIC CONDUIT (IMC) CONDUITS, UNLESS OTHERWISE SPECIFIED. THE WIRING SHALL BE IN ACCORDANCE WITH THE NATIONAL ELECTRICAL CODE (NEC) AND THE NATIONAL ELECTRICAL CONTRACTORS ASSOCIATION (NECA) STANDARDS. THE WIRING SHALL BE IN ACCORDANCE WITH THE NATIONAL ELECTRICAL CODE (NEC) AND THE NATIONAL ELECTRICAL CONTRACTORS ASSOCIATION (NECA) STANDARDS.
- ALL WIRING SHALL BE CONFORM TO THE NATIONAL ELECTRICAL CODE (NEC) AND THE NATIONAL ELECTRICAL CONTRACTORS ASSOCIATION (NECA) STANDARDS. THE WIRING SHALL BE IN ACCORDANCE WITH THE NATIONAL ELECTRICAL CODE (NEC) AND THE NATIONAL ELECTRICAL CONTRACTORS ASSOCIATION (NECA) STANDARDS.
- THE MINIMUM SIZE OF CONDUIT SHALL BE 1.25 INCH FOR LIGHTING AND 1.5 INCH FOR ALL OTHER WIRING. THE MINIMUM SIZE OF CONDUIT SHALL BE 1.25 INCH FOR LIGHTING AND 1.5 INCH FOR ALL OTHER WIRING.
- CONDUITS SHALL BE INSTALLED IN ACCORDANCE WITH THE NATIONAL ELECTRICAL CODE (NEC) AND THE NATIONAL ELECTRICAL CONTRACTORS ASSOCIATION (NECA) STANDARDS. THE WIRING SHALL BE IN ACCORDANCE WITH THE NATIONAL ELECTRICAL CODE (NEC) AND THE NATIONAL ELECTRICAL CONTRACTORS ASSOCIATION (NECA) STANDARDS.
- THE MINIMUM HEIGHTS OF WIRING SERVICES SHALL BE AS FOLLOWS:
 - 4.1 LIGHT SWITCHES 1.80m ABOVE FLOOR FINISH
 - 8.1 CONVENIENCE OUTLETS 0.30m ABOVE FLOOR FINISH
 - 8.2 TELEPHONE OUTLETS 0.30m ABOVE FLOOR FINISH
 - 8.3 FANAL NUMBER & CORNER 1.80m ABOVE FLOOR FINISH
 - 8.4 FANAL NUMBER & CORNER 1.80m ABOVE FLOOR FINISH
- ALL WIRING SHALL BE CONFORM TO THE NATIONAL ELECTRICAL CODE (NEC) AND THE NATIONAL ELECTRICAL CONTRACTORS ASSOCIATION (NECA) STANDARDS. THE WIRING SHALL BE IN ACCORDANCE WITH THE NATIONAL ELECTRICAL CODE (NEC) AND THE NATIONAL ELECTRICAL CONTRACTORS ASSOCIATION (NECA) STANDARDS.
- FOR EACH SPARE BRANCH CIRCUIT IN PANEL BOARDS, PROVIDE ONE 20mm² CABLE THE CONDUITS TERMINATED IN A 100mm² OBTAINABLE NON METALIC DUCT.

LEGEND

	LIGHTING OUTLET
	REFRIGERATOR OUTLET
	WEATHERPROOF CONVENIENCE OUTLET
	DUPLEX CONVENIENCE OUTLET
	LIGHTING & POWER PANEL BOARD
	ELECTRICAL SERVICE ENTRANCE
	CIRCUIT HOME RUN
	SINGLE POLE SWITCH
	2 - GANG SWITCH
	LIGHTING LINE, CONCEALED ON CEILING
	POWER LINE, CONCEALED ON FLOOR

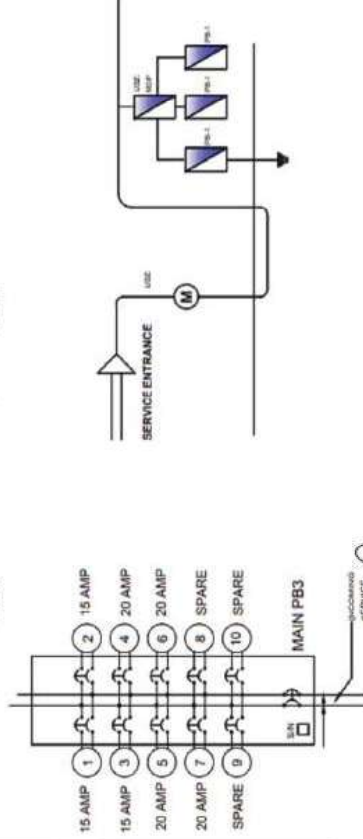
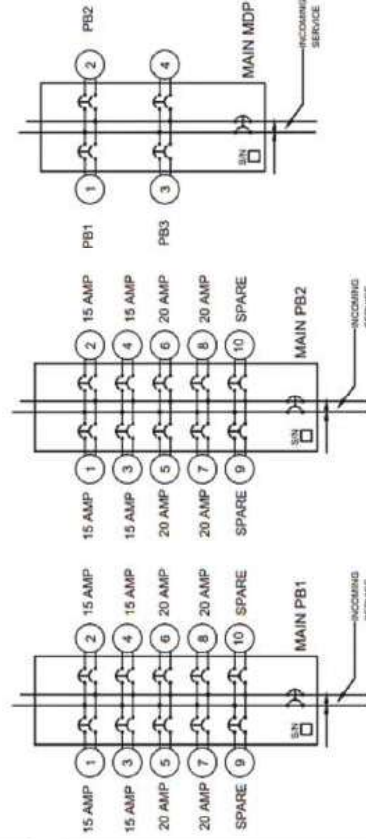

REVISIONS

SHEET CONTENTS:
SCHEDULE OF LOADS

APPROVED BY:
ASHARY A. BANTO, JD. CESE
REGIONAL DIRECTOR

RECOMMENDING APPROVAL:
M. ELENA M. NARCISO
ACTING VOCATIONAL SCHOOL SUPERINTENDENT

OWNER:
TESDA - ISAT
ADDRESS: TESDABAY, CALAMAGUI, CITY OF LAGAN, ISABELA

PROJECT TITLE:
"PROPOSED 3 - STOREY POF LEVEL 5 (DIPLOMA) BUILDING"
LOCATION: TESDABAY, CALAMAGUI, CITY OF LAGAN, ISABELA



Section VIII. Bill of Quantities

Notes on the Bill of Quantities

Objectives

The objectives of the Bill of Quantities are:

- a) to provide sufficient information on the quantities of Works to be performed to enable Bids to be prepared efficiently and accurately; and
- b) when a Contract has been entered into, to provide a priced Bill of Quantities for use in the periodic valuation of Works executed.

In order to attain these objectives, Works should be itemized in the Bill of Quantities in sufficient detail to distinguish between the different classes of Works, or between Works of the same nature carried out in different locations or in other circumstances which may give rise to different considerations of cost. Consistent with these requirements, the layout and content of the Bill of Quantities should be as simple and brief as possible.

Daywork Schedule

A Daywork Schedule should be included only if the probability of unforeseen work, outside the items included in the Bill of Quantities, is high. To facilitate checking by the Entity of the realism of rates quoted by the Bidders, the Daywork Schedule should normally comprise the following:

- a) A list of the various classes of labor, materials, and Constructional Plant for which basic daywork rates or prices are to be inserted by the Bidder, together with a statement of the conditions under which the Contractor will be paid for work executed on a daywork basis.
- b) Nominal quantities for each item of Daywork, to be priced by each Bidder at Daywork rates as Bid. The rate to be entered by the Bidder against each basic Daywork item should include the Contractor's profit, overheads, supervision, and other charges.

Provisional Sums

A general provision for physical contingencies (quantity overruns) may be made by including a provisional sum in the Summary Bill of Quantities. Similarly, a contingency allowance for possible price increases should be provided as a provisional sum in the Summary Bill of Quantities. The inclusion of such provisional sums often facilitates budgetary approval by avoiding the need to request periodic supplementary approvals as the future need arises. Where such provisional sums or contingency allowances are used, the SCC should state the manner in which they will be used, and under whose authority (usually the Procuring Entity's).

The estimated cost of specialized work to be carried out, or of special goods to be supplied, by other contractors (refer to **GCC** Clause 7) should be indicated in the relevant part of the Bill of Quantities as a particular provisional sum with an appropriate brief description. A separate procurement procedure is normally carried out by the Procuring Entity to select such specialized contractors. To provide an element of competition among the Bidders in respect of any facilities, amenities, attendance, etc., to be provided by the winning Bidder as prime Contractor for the use and convenience of the specialist contractors, each related

provisional sum should be followed by an item in the Bill of Quantities inviting the Bidder to quote a sum for such amenities, facilities, attendance, etc.

Signature Box

A signature box shall be added at the bottom of each page of the Bill of Quantities where the authorized representative of the Bidder shall affix its signature. Failure of the authorized representative to sign each and every page of the Bill of Quantities shall be a cause for rejection of its bid.

These Notes for Preparing a Bill of Quantities are intended only as information for the Procuring Entity or the person drafting the Bidding Documents. They should not be included in the final documents.

Project: **Creation of Isabela School of Arts and Trades (ISAT)
Diploma Center**
 Location: **Calamagui 2nd, City of Ilagan, Isabela**
 Owner: **TESDA ISAT**
 Subject: **Bill of Quantities and Cost Estimates**

Item No.	Particulars	Quantity	Unit	Unit Cost	Material Cost	Labor Cost	Total Cost
I	Preliminaries						
	Temporary Facilities	1	lot				-
	Fencing	1	lot				-
	Signages	1	lot				-
	Permits and Clearances	1	lot				-
		<i>sub-total</i>			-	-	-
II	Earthworks						
	Excavation	600	cu.m				-
	Backfill and Compaction	504	cu.m				-
	Gravel Bedding	54	cu.m				-
	Soil Poisoning	6	gals				-
		<i>sub-total</i>			-	-	-
III	Concrete Works						
	3000 psi Ready Mix Concrete	180	cu.m				-
	Cement	2,100	bags				-
	Washed Sand	116	cu.m				-
	3/4 Crush Gravel	232	cu.m				-
		<i>sub-total</i>			-	-	-
IV	Rebar Works						
	20mmØ RSB Gr. 60 psi	1,230	pcs				-
	16mmØ RSB Gr. 60 psi	1,300	pcs				-
	12mmØ RSB Gr. 40 psi	2,314	pcs				-
	10mmØ RSB Gr. 33 psi	6,850	pcs				-
	#16 Tie Wire	150	rolls				-
		<i>sub-total</i>			-	-	-
V	Formworks and Scaffoldings						
	3/4 Phenolic Form	250	pcs				-
	Assorted Good Lumber	5,000	bd.ft				-
	1 1/2 French Tube Sch. 40	500	pcs				-
	1 1/2 French Tube Sch. 20	250	pcs				-
	Fixed Clamp	800	pcs				-
	Swivel Clamp	200	pcs				-
	Assorted CW Nail	30	box				-
	1.0mm THK Steel Flat Deck	2,800	ln.m				-
		<i>sub-total</i>			-	-	-
VI	Masonry Works/Partition Wall						
	Masonry Wall						
	5" CHB	5,000	pcs				-
	4" CHB	12,000	pcs				-
	Cement	1,813	bags				-
	Sand	73	cu.m				-
	3/4 Gravel	10	cu.m				-
	10mmØ RSB Gr. 33 psi	937	pcs				-
	#16 Tie Wire	2	rolls				-
	Flying Sand	53	cu.m				-
	Cementitious Water Proofing Compound	25	gals				-
	Paint Roller	6	pcs				-
	Paint Brush	6	pcs				-
	CR Partitions						
	HPL Board	16	pcs				-
	Accessories	1	lot				-
	3rd Floor Room Partitions						
	PVC Accordion Door with Accessories	4	sets				-
		<i>sub-total</i>			-	-	-

Prepared by and Certified Correct:

Printed Name of Bidder's Authorized Representative over Signature
 Position of the Authorized Representative

VII	Roofing Works						
	Framing						
	1/4 x 2 x 5 C-Channel	48	pcs				-
	1.5 x 2 x 5 C - Purlins	105	pcs				-
	1/4x3x3 Angular Bar	3	pcs				-
	Welding Rod	100	kgs				-
	Metal Primer	8	gals				-
	2" Paint Brush	6	pcs				-
	4" Paint Roller	6	pcs				-
	12mm Plain Round Bar	55	pcs				-
	12mm Sag Rod	14	pcs				-
	Roofing						
	0.6mm Rib Type Pre-painted Long Span	360	ln.m				-
	Wall Flushing	28	pcs				-
	Foam Insulation	8	rolls				-
	Chicken Wire	12	rolls				-
	Tekscrew	3,500	pcs				-
	5/32 x 3/4 Blind Rivets	2	box				-
		<i>sub-total</i>				-	-
VIII	Electrical Works						
	LIGHTING & SMALL POWER SYSTEM						
	Twin head Emergency light w/ 2hrs battery pack	26	pc/s				-
	Junction box metal	150	pcs				-
	Utility Box	100	pcs				-
	Square box 4x4	10	pcs				-
	Industrial lamp 2X40W LEDtube single ended, Open type w/ mirror reflector	70	set				-
	Pinlight (Downlight) 18w, round ST Ecolum	21	pcs				-
	Pinlight (Downlight) 12w, ST square Ecolum	20	pcs				-
	2-gang switch, wide series	9	Set				-
	S3W switch, wide series	4	Set				-
	2-gang outlet set, wide series	40	set				-
	2-gang outlet set, weather proof	7	set				-
	Electrical tape	50	pcs				-
	AUXILIARY SYSTEM						
	32-ch 1.5U K Series AcuSense 4K NVR	4	sets				-
	WESTERN DIGITAL PURPLE 8TB	8	pcs				-
	ColorVu Lite- 2mp 2.8mm lens, 30m IR range, built in mic PoE, H.265+, IP67 turret IP camera	26	pcs				-
	2 MP ColorVu MD 2.0 Fixed Bullet Network Camera	4	pcs				-
	16 Ports Gigabit Unmanaged	4	pcs				-
	8 Port Gigabit Smart POE Switch	3	pcs				-
	4 Port Gigabit Smart POE Switch	3	pcs				-
	Ubiquiti UISP-Cable-Pro / TC-Pro UISP Cable Pro Outdoor Carrier 1000ft / UTP CAT5e Cable (UISP-Cable-Pro)305Meters 24AWG	4	pcs				-
	UTP CAT 6 Ethernet Network Cable INDOOR 305m, Core dia.: 0.53mm, white	1	box				-
	Metal Enclosure Coating WaterProof Box [H400 x W300 x D150mm]	6	set				-
	Data Cabinet 6U	4	pcs				-
	10ah AC breaker	10	pcs				-
	Outlet 3 gang	10	pcs				-
	Female plug	10	pcs				-
	Standard Wire #12 150 m	1	box				-
	Horizontal PDU	1	pcs				-
	Junction Box Water Proof 100x100x40mm	60	pcs				-
	CAT6 gold plated RJ45	1	box				-
	Cat6 Patch cored Machine Made	4	pcs				-
	Adhesive Electrical Tape	1	pcs				-

Prepared by and Certified Correct:

Printed Name of Bidder's Authorized Representative over Signature
Position of the Authorized Representative

	ELECTRICAL WIRES, CONDUITS AND FITTINGS						
	100mm2 THHN wire	60	metrs				-
	14mm2 THHn wire	300	metrs				-
	5.5mm2 THHN Wire	450	metrs				-
	3.5mm2 THHN Wire	20	box				-
	2.0mm2 THHN Wire	15	box				-
	PVC pipe 3"	5	pcs				-
	PVC adapter 3"	4	pcs				-
	entrance cap 3"	1	pc				-
	Long elbow 3"	4	pcs				-
	PVC pipe 1 1/2"	20	pcs				-
	long elbow 1 1/2"	6	pcs				-
	PVC Pipe 1/2"	400	pcs				-
	long elbow 1/2"	50	pcs				-
	PVC Pipe 3/4"	100	pcs				-
	long elbow 3/4"	50	pcs				-
	DISTRIBUTION SYSTEM						
	MCB w/ Circuit breaker 1-200AT 3P	1	set				-
	MDP 4hole, 1 Center Main Circuit breaker 1- 200 AT 3P, 4- 60AT 3P, 220V	1	set				-
	Panel Board 1 Center Main, 20 Branches, Circuit breaker: 1- 60 AT 3P, 4- 20AT 3P, 7- 30AT 2P, 4- 20AT 2P, 5-15AT 2P, 220V	3	set				-
	Circuit Breaker 30AT w/ nema 3R enclosure, ARC	17	set				-
	Panel Board Center main - 20AT 3P,220 V	8	set				-
	MISCELLANEOUS						
	20KW Grid-Tied Solar Panel System - 3 Phase	1	lot				-
			<i>sub-total</i>			-	-
IX	Plumbing Works						
	Sanitary						
	Elongated Wall Mounted Solar Powered Sensor Toilet	8	sets				-
	Lavatory with Automatic Touchless Faucet	8	sets				-
	Smart Censor Urinals	4	sets				-
	Stainless Steel Rectangular Floor Drain	10	pcs				-
	Kitchen Sink	1	sets				-
	4" PVC Pipe	40	pcs				-
	2" PVC Pipe	30	pcs				-
	4" PVC Wye	50	pcs				-
	4"x45 PVC Wye	50	pcs				-
	2"x45 PVC Wye	50	pcs				-
	4" PVC Elbow	35	pcs				-
	2" PVC Elbow	35	pcs				-
	4" PVC Clean Out	35	pcs				-
	Solvent Cement	1	lit				-
	Water Distribution						
	3/4 PPR Pipe	30	pcs				-
	1/2 PPR Pipe	40	pcs				-
	3/4 PPR Elbow	30	pcs				-
	1/2 PPR Elbow	50	pcs				-
	3/4 PPR Tee	30	pcs				-
	1/2 PPR Tee	30	pcs				-
	1/2 Female Adapter	40	pcs				-
	1/2 PPR Union Patente	10	pcs				-
	Bidet	8	pcs				-
	Faucet Wall Type	10	pcs				-
	Angle Valve	15	pcs				-
	Double Angle Valve	15	pcs				-
	Teflon Tape	30	rolls				-
	Stainless Steel Water Tank (5000 liters) with accessories	1	set				-
	Drinking Fountain	3	sets				-

Prepared by and Certified Correct:

Printed Name of Bidder's Authorized Representative over Signature
Position of the Authorized Representative

	Fire Protection						
	Design, Supply and Installation of Automatic Sprinkler System	1	lot				-
	Septic Tank						
	5" CHB	600	pcs				-
	Cement	30	bags				-
	Sand	10	cu.m				-
	Gravel	5	cu.m				-
	12mmØ RSB Gr. 40 psi	85	pcs				-
	Storm Drainage						
	4" PVC Pipe	35	pcs				-
	4" PVC Elbow	16	pcs				-
	12" RC Pipe	36	pcs				-
	16"x16" Steel Grating	8	pcs				-
		<i>sub-total</i>				-	-
X	Tile Works/Floor and Wall Finishes						
	60x60 Granite Tiles	680	pcs				-
	30x30 Floor Tiles	720	pcs				-
	30x60 Wall Tiles	730	pcs				-
	60x60 Outdoor Tiles	700	pcs				-
	30x30 Anti-Slip Floor tiles (Stair)	900	pcs				-
	Tile Adhesive	350	bags				-
	Tile Grout	45	packs				-
	Sand	40	cu.m				-
	9"x4' Viny Tiles	1,900	pcs				-
	Acrylic Flooring Adhesives	24	pails				-
		<i>sub-total</i>				-	-
XI	Ceiling Works						
	0.6mm Metal Furring	120	pcs				-
	0.8mm Carrying Channel	80	pcs				-
	W-Clip	700	pcs				-
	Fiber Cement Board	120	pcs				-
	Black Screw	8,000	pcs				-
	Blind Rivets	5	box				-
	2.0 x 2 x 2 Tubular Steel (hanger support)	36	pcs				-
	Welding Rod	20	kgs				-
		<i>sub-total</i>				-	-
XII	Painting Works						
	Concrete Neutralizer	7	gals				-
	Flat Latex	29	pail				-
	Ready Mix Paint	24	pail				-
	Masonry Putty	30	gals				-
	Skimcoat	350	bags				-
	#80 Sanding Paper	300	pcs				-
	Paint Tray	30	pcs				-
	3" Paint Brush	25	pcs				-
	2" Paint Brush	25	pcs				-
	7" Paint Roller	25	pcs				-
	4" Paint Roller	25	pcs				-
	Epoxy Primer White (Ceiling)	48	gals				-
	Acrylic Thinner	24	gals				-
		<i>sub-total</i>				-	-
XIII	Doors and Windows						
	5' x 7' Analok Awning Window	32	sets				-
	5' x 3' Analok Awning Window	1	set				-
	5' x 6' Analok Awning Window	1	set				-
	2' x 8' Analok Awning Window	1	set				-
	0.9m x 2.4m Steel Door with Glass and Accessories	19	sets				-
	0.8m x 2.4 Aluminum Door with Accessories	4	sets				-
	PWD Door with Accessories	1	set				-
		<i>sub-total</i>				-	-

Prepared by and Certified Correct:

Printed Name of Bidder's Authorized Representative over Signature
Position of the Authorized Representative

XIV	Miscellaneous						
	Stainless Steel Railings	120	ln.m				-
	Landscape	4	sets				-
	Trellis	1	lot				-
	Decorative Bricks	40	sq.m				-
	Acrylic Building Signages	1	lot				-
	Classroom Whiteboard Multi Screen Slide	7	sets				-
	Laboratory Center Table with End Sink (3600L x 1000W x 900H)	2	sets				-
	Smart Interactive Digital Whiteboard 75"	7	sets				-
	Teacher's Desk	7	sets				-
	Bamboo & Steel Student Desk Chair	280	pcs				-
	Office Table	10	sets				-
	Swivel Chair	10	sets				-
	125 KVA Standby Diesel Power Generator	1	lot				-
		<i>sub-total</i>					-

Material Cost	-
Labor Cost	-
OCM (12%)	-
Contractor's Profit (8%)	-
VAT (5%)	-
TOTAL ESTIMATED COST	-

Prepared by and Certified Correct:

Printed Name of Bidder's Authorized Representative over Signature
Position of the Authorized Representative

Section IX. Philippine Bidding Documents Related Forms

Notes to the Philippine Bidding Document Related Forms

The Bidder shall complete and submit with its Bid the **Bid Form**, together with the Bill of Quantities, detailed estimates that include a summary sheet indicating the unit prices of construction materials, labor rates, and equipment rentals used in coming up with the Bid, and Cash Flow by Quarter, in accordance with **ITB** Clause 13, and all those requirements indicated in the Bidding Documents and the format set out in this Section.

When requested in the BDS, the Bidder should provide the **Bid Security**, either in the form included hereafter or in another form acceptable to the Procuring Entity, pursuant to **ITB** Clause 16.

The **Contract Form**, when it is finalized at the time of contract award, should incorporate any correction or modification to the accepted Bid resulting from price corrections. The needed attachments, as aforementioned which form part of the contract should be modified accordingly.

The **Omnibus Sworn Statement** must be completed by all Bidders in accordance with **ITB** Clause 4.3. Failure to do so and submit it with the Bid shall result in the rejection of the Bid and the Bidder's disqualification.

The **Performance Securing Declaration and Bank Guarantee Form for Advance Payment** shall be completed only by the successful Bidder in accordance with one of the forms indicated herein or in another form acceptable to the Procuring Entity and pursuant to **GCC** Clause 12 and its corresponding SCC provision.

TABLE OF CONTENTS

Bid Form	96
Contract Form	98
Omnibus Sworn Statement Form	101
Bid Securing Declaration Form.....	105

Bid Form for Procurement of Infrastructure Projects

[Note: The duly accomplished form shall be submitted with the Bid]

BID FORM

Project Identification No.: **TESDAR02-2026-002**

To: **TESDA-Regional Office II**
Carig Norte, Tuguegarao City, Cagayan

Having examined the Philippine Bidding Documents (PBD) including the Supplemental Bid Bulletin Numbers *[insert numbers]*, the receipt of which is hereby duly acknowledged, we, the undersigned, declare that:

- a) I/We have no reservation to the PBD, including the Supplemental Bid Bulletins, for the Procurement Project **Creation TESDA-ISAT Diploma Center (Rebidding)**;
- b) I/We offer to execute the Works for this Contract in accordance with the PBD;
- c) The total price of our Bid in words and figures, excluding any discount offered below, is *[insert information]*
- d) The discounts offered and the methodology for their application, if any, are: *[insert information]*; or indicate N/A if no discount offered
- e) The total bid price in words and figures, after applying the applicable discount, includes the cost of all taxes, such as, but not limited to *[specify the applicable taxes, e.g. (i) value added tax (VAT), (ii) income tax, (iii) local taxes, and (iv) other fiscal levies and duties]*, which are itemized in the Detailed Estimates.
- f) This Bid shall remain valid within a period stated in the PBD, and it shall be binding upon me/us at any time before the expiration of that period;
- g) If our bid is accepted, I/we commit to enter to a contract and provide a performance security in the form, amounts, and within the times prescribed in the PBD, and hereby acknowledge the consequences under the IRR of RA No. 12009 on forfeiture of Bid Security or enforcement of Bid Securing Declaration and on Blacklisting.

Until a formal Contract is prepared and executed, this Bid, together with your written acceptance thereof and your Notice of Award, shall be binding upon the Bidder.

I/We understand that you are not bound to accept the Lowest Calculated Bid or any Bid you may receive.

I/We certify/confirm that we comply with the eligibility requirements pursuant to the PBD.

The undersigned is authorized to submit the bid on behalf of *[Name of the Bidder]* as evidenced by the attached *[State the Written Authority]*.

I/We acknowledge that failure to sign each and every page of this Bid Form, including the attached Schedule of Prices, shall be a ground for the rejection of our bid.

Duly authorized to sign the Bid for and behalf of:

[Insert Bidder's Name]

[Signature over Printed Name]

[Position/Designation]

[Date]

Contract Form

[Note: The duly accomplished form is not required to be submitted with the Bid but shall be submitted within ten (10) days after receiving the Notice of Award]

CONTRACT FOR CREATION OF TESDA-ISAT DIPLOMA CENTER

THIS CONTRACT executed on the ____ day of _____ 20 ____ between:

TECHNICAL EDUCATION AND SKILLS DEVELOPMENT AUTHORITY - REGIONAL OFFICE II, a government agency of the Republic of the Philippines, hereinafter called “the Entity”;

-and-

[Name of Contractor] Filipino of legal age or a company duly organized and existing under the laws of [city and country], with principal office at [insert address], hereinafter called “the Contractor”.

WHEREAS, the Entity invited Bids for certain goods and ancillary services, particularly **Creation of Isabela of School of Arts and Trades Diploma Center with Six (6) Classrooms, One (1) Laboratory Room, Library, Clinic, Faculty Rooms and Restrooms;**

WHEREAS, the Contractor submitted a responsive bid and was awarded the contract for the procurement in the total amount of *[Contract price in words and figures, including currency]*, hereinafter referred to as the “Contract Price.”

NOW, THEREFORE, for and in consideration of the foregoing premises, the parties hereby agree as follows:

- 1) Unless otherwise stated, terms and expressions used in this Contract shall have the same meanings as those assigned to them in the Conditions of Contract, which form an integral part of this Contract.
- 2) The following documents as required by the Implementing Rules and Regulations of Republic Act No. 12009 shall be deemed to form and be read and construed as integral part of this Contract, viz.:
 - a) Philippine Bidding Documents (PBD);
 - i. Drawings/Plans;
 - ii. Scope of Work;
 - iii. Invitation to Bid;
 - iv. Instructions to Bidders;
 - v. Bid Data Sheet;
 - vi. Bid Form, including all the documents/statements contained in the Bidder's bidding envelopes, as annexes, and all other documents submitted (e.g., Bidder's response to request for clarifications on the bid), including corrections to the bid, if any, resulting from the Procuring Entity's bid evaluation;
 - vii. Bill of Quantities;
 - viii. General and Special Conditions of Contract;
 - ix. Supplemental Bid Bulletins, if any; and

- x. Other contract documents that may be required by existing laws and/or the Entity.
 - b) Winning bidder's bid, including the Eligibility Requirements, Technical and Financial Proposals, and all other documents or statements submitted;
 - c) Performance Security;
 - d) Notice of Award of Contract; and the Bidder's Conforme thereto; and
 - e) Other contract documents that may be required by existing laws and/or the Procuring Entity concerned in the PBD, such as but not limited to the Notice to Proceed and Warranty Security.
- 3) In consideration of the Contract Price of *[Contract Price in words and figures]*, or such other sums as may be determined in accordance with the terms of the Contract, the Supplier agrees to deliver and perform the items and related services for the **CREATION TESDA-ISAT DIPLOMA CENTER (REBIDDING)** described herein in accordance with the terms and conditions specified in the Contract and its annexed documents.
 - 4) The **TECHNICAL EDUCATION AND SKILLS DEVELOPMENT AUTHORITY - REGIONAL OFFICE II** agrees to pay the above-mentioned sum to the Supplier in accordance with the schedule and manner provided in the Bidding Documents and its annexes.
 - 5) Any dispute, difference, or claim arising out of or relating to this Contract, including its existence, validity, interpretation, breach, or termination thereof, may be submitted to arbitration or other form of alternative dispute resolution in accordance with the applicable law, such as Republic Act (RA) No. 9285 (Alternative Dispute Resolution Act of 2004) or Executive Order No 1008, series 1985 (Construction Industry Arbitration Law).

IN WITNESS WHEREOF, the parties hereto have caused this Contract to be executed in accordance with the laws of the Republic of the Philippines on the day and year first above written

For the Procuring Entity
 Head of the Procuring Entity or Duly
 Authorized Representative

For the Bidder
 Duly authorized to sign the Contract
 for and behalf of *[Bidders Name]*:

ASHARY A. BANTO, JD, CESE
 Regional Director
[Date]

[Signature over Printed Name]
[Position/Designation]
[Date]

Signed in the presence of:

[Name and Signature]

[Name and Signature]

Witness – Procuring Entity

Witness- Supplier

ACKNOWLEDGMENT

BEFORE ME, A Notary Public for and in the _____, City/Province of _____, this _____ day of _____, 20____, personally appeared the above-named persons who have satisfactorily proven to me their identity, through their identifying documents written below their names and signatures, that they are the same persons who executed and voluntarily signed the foregoing instrument consisting of _____ pages, including this page where this Acknowledgement is written, which they acknowledged before me as their free and voluntary act and deed.

WITNESS MY HAND AND SEAL this ____ day of *[month]* *[year]*.

NAME OF NOTARY PUBLIC

Notarial Commission No. _____

Notary Public for _____ until _____

Roll of Attorneys No. _____

PTR No. __, *[date issued]*, *[place issued]*

IBP No. __, *[date issued]*, *[place issued]*

Doc. No. _____

Page No. _____

Book No. _____

Series of _____

Omnibus Sworn Statement Form

[Note: The duly accomplished form shall be submitted with the Bid]

REPUBLIC OF THE PHILIPPINES)
CITY/MUNICIPALITY OF _____) S.S.

OMNIBUS SWORN STATEMENT

I, *[Name of Affiant]*, of legal age, *[Civil Status]*, *[Nationality]*, and with residence at *[Address of Affiant]*, after having been duly sworn in accordance with law, do hereby depose and state that:

1) *Select one, delete the others:*

- *If sole proprietorship:* I am the sole proprietor or authorized representative of *[Name of Bidder]* with office address at *[Address of Bidder]*;
- *If partnership, corporation, cooperative, or joint venture:* I am the duly authorized and designated representative of *[Name of Bidder]* with office address at *[Address of Bidder]*;
- *If individual consultant not registered under a sole proprietorship, in case of Consulting Services:* I am the individual consultant or authorized representative of *[Name of Bidder]* with office address at *[Address of Bidder]*;

2) *Select one, delete the others:*

- *If sole proprietorship:* As the owner and sole proprietor or authorized representative of *[Name of Bidder]*, I have full power and authority to do, execute and perform any and all acts necessary to participate, submit the bid, and to sign and execute the ensuing contract for **CREATION TESDA-ISAT DIPLOMA CENTER (REBIDDING)** of the **TECHNICAL EDUCATION AND SKILLS DEVELOPMENT AUTHORITY - REGIONAL OFFICE II** *[insert "as supported by the attached duly notarized Special Power of Attorney" for authorized representative]*;
- *If partnership, corporation, cooperative, or joint venture:* I am granted full power and authority to do, execute and perform any and all acts necessary to participate, submit the bid, and to sign and execute the ensuing contract for **CREATION TESDA-ISAT DIPLOMA CENTER (REBIDDING)** of the **TECHNICAL EDUCATION AND SKILLS DEVELOPMENT AUTHORITY - REGIONAL OFFICE II**, as supported by the attached duly notarized Special Power of Attorney, Board/Partnership Resolution, or Secretary's Certificate, whichever is applicable;
- *If individual consultant not registered under a sole proprietorship, in case of Consulting Services:* As the individual consultant or authorized representative of *[Name of Bidder]*, I have full power and authority to do, execute and perform any and all acts necessary to participate, submit the bid, and to sign and execute the

ensuing contract for **CREATION TESDA-ISAT DIPLOMA CENTER (REBIDDING)** of the **TECHNICAL EDUCATION AND SKILLS DEVELOPMENT AUTHORITY - REGIONAL OFFICE II**, as supported by the attached duly notarized Special Power of Attorney *for authorized representative*;

- 3) *[Name of Bidder]* is not “blacklisted” or barred from bidding by the Government of the Philippines or any of its agencies, offices, corporations, or Local Government Units, foreign government/foreign or international financing institution whose blacklisting rules have been recognized by the Government Procurement Policy Board; by itself or by relation, membership, association, affiliation, or controlling interest with another blacklisted person or entity;
- 4) Each of the documents submitted in satisfaction of the bidding requirements is an authentic copy of the original, complete, and all statements and information provided therein are true and correct;
- 5) *[Name of Bidder]* is authorizing the Head of the Procuring Entity or its duly authorized representative(s) to verify all the documents submitted;
- 6) *Select one, delete the others:*
 - *If sole proprietorship* : The *[Name of Bidder]* and its spouse are not related by consanguinity or affinity up to the third civil degree to the Head of the Procuring Entity, Procurement Agent (if engaged), End-User or Implementing Unit, project consultants, head of the Project Management Office, or the members of the Bids and Awards Committee (BAC), the Technical Working Group, and the BAC Secretariat;
 - *If partnership* : The partnership itself and the partners of *[Name of Bidder]* are not related by consanguinity or affinity up to the third civil degree to the Head of the Procuring Entity, Procurement Agent (if engaged), End-User or Implementing Unit, project consultants, head of the Project Management Office, or the members of the Bids and Awards Committee (BAC), the Technical Working Group, and the BAC Secretariat;
 - *If cooperative*: The cooperative itself and members of the board of directors, general manager, or chief executive officer of *[Name of Bidder]* are not related by consanguinity or affinity up to the third civil degree to the Head of the Procuring Entity, Procurement Agent (if engaged), End-User or Implementing Unit, project consultants, head of the Project Management Office, or the members of the Bids and Awards Committee (BAC), the Technical Working Group, and the BAC Secretariat;
 - *If corporation, or joint venture*: The corporation or joint venture itself, and officers, directors, and controlling stockholders of *[Name of Bidder]* are not related by consanguinity or affinity up to the third civil degree to the Head of the Procuring Entity, Procurement Agent (if engaged), End-User or Implementing Unit, project consultants, head of the Project Management Office, or the members of the Bids and Awards Committee (BAC), the Technical Working Group, and the BAC Secretariat;

- *If individual consultant not registered under a sole proprietorship, in case of Consulting Services:* The individual consultant and its spouse are not related by consanguinity or affinity up to the third civil degree to the Head of the Procuring Entity, Procurement Agent (if engaged), End-User or Implementing Unit, project consultants, head of the Project Management Office, or the members of the Bids and Awards Committee (BAC), the Technical Working Group, and the BAC Secretariat;
- 7) It is understood that failure to faithfully disclose its relationship with the HoPE, members of the BAC, the TWG, and the BAC Secretariat, the head of the PMO or the end-user unit or implementing unit, and the project consultants of the Procuring Entity, or of the procurement agent by consanguinity or affinity up to the third civil degree, as well as its submission of beneficial ownership information containing false entries shall be subject to blacklisting under Section 100 of the IRR of RA No. 12009, without prejudice to criminal and civil liabilities under applicable laws, including their accessory penalties, if any.

Select one, delete the rest:

- *In case of corporations:* [Name of Bidder] declares its beneficial ownership information consistent with its updated General Information Sheet or Beneficial Ownership Declaration Form or any other document duly submitted to the SEC and has maintained a valid and updated file therein in compliance with Sections 20.2.9.1, 81, and 82 of the IRR of Republic Act (RA) No. 12009.
 - *In case of Foreign Bidders:* [Name of Bidder] submitted an appropriate equivalent document in English issued by the country of the bidder concerned in accordance with Section 20.2.9.2 of the IRR of RA No. 12009.
- 8) [Name of Bidder] complies with existing labor laws and standards; and
- 9) [Name of Bidder] is aware of and has undertaken the following responsibilities as a Bidder:
- a) Carefully examine all of the Bidding Documents;
 - b) Acknowledge all conditions, local or otherwise, affecting the implementation of the Contract;
 - c) Made an estimate of the facilities available and needed for the contract to be bid, if any; and
 - d) Inquire or secure Supplemental Bid Bulletin(s) issued for the **CREATION TESDA-ISAT DIPLOMA CENTER (REBIDDING)**.
- 10) [Name of Bidder] did not give or pay directly or indirectly, any commission, amount, fee, or any form of consideration, pecuniary or otherwise, to any person or official, personnel or representative of the government in relation to any procurement project or activity.
- 11) In case advance payment was made or given to [Name of Bidder], failure to perform or deliver any of the obligations and undertakings in the contract shall be sufficient grounds to constitute criminal liability under existing laws.

IN WITNESS WHEREOF, I have hereunto set my hand this ___ day of ___, 20__ at _____, Philippines.

Duly authorized to sign the Bid for and behalf of:

[Insert Bidder's Name]

[Affiant's Signature over Printed Name]

[Position/Designation]

[Date]

JURAT

SUBSCRIBED AND SWORN to before me this ____ day of *[month]* *[year]* at *[place of execution]*, Philippines. Affiant/s is/are personally known to me and was/were identified by me through competent evidence of identity as defined in the 2004 Rules on Notarial Practice (A.M. No. 02-8-13-SC). Affiant/s exhibited to me his/her *[insert type of government identification card used]*, with his/her photograph and signature appearing thereon, with no. _____.

WITNESS MY HAND AND SEAL this ____ day of *[month]* *[year]*.

NAME OF NOTARY PUBLIC

Notarial Commission No. _____

Notary Public for _____ until _____

Roll of Attorneys No. _____

PTR No. __, *[date issued]*, *[place issued]*

IBP No. __, *[date issued]*, *[place issued]*

Doc. No. _____

Page No. _____

Book No. _____

Series of _____.

Bid Securing Declaration Form

*[The duly accomplished form shall be submitted with the Bid
if bidder opts to provide this type of bid security]*

REPUBLIC OF THE PHILIPPINES)
CITY/MUNICIPALITY OF _____) S.S.

BID SECURING DECLARATION

Project Identification No.: TESDAR02-2026-002

To: **TESDA-Regional Office II**
Carig Norte, Tuguegarao City, Cagayan

I/We, the undersigned, declare that:

- 1) I/We understand that, according to your conditions, bids must be supported by a Bid Security, which may be in the form of a Bid Securing Declaration;
- 2) I/We accept that:
 - a) I/We shall enter into contract with the Procuring Entity and furnish the required performance security within ten (10) calendar days as indicated in the Bidding Documents, from receipt of the Notice of Award;
 - b) I/we will be automatically disqualified from bidding for any procurement contract with any Procuring Entity upon receipt of your Blacklisting Order; and
 - c) I/We will pay the applicable fine within fifteen (15) days from receipt of the written demand by the Procuring Entity for the commission of acts resulting to the enforcement of the Bid Securing Declaration under Sections 52.2 (a), 63.2, 69.1 and 100, except 100.3 (c), of the IRR of RA No. 12009; without prejudice to other legal action the government may undertake;

	<i>Applicable Fine</i>
a) in the case of a single bidder	<ol style="list-style-type: none">i) two percent (2%) of the Approved Budget for the Contract (ABC); orii) the difference between the evaluated bid price and the ABC whichever is higher
b) in the case of multiple bidders	<ol style="list-style-type: none">i) two percent (2%) of the ABC; orii) the difference between the evaluated bid prices with the bidder with Lowest

	Calculated/Highest Rated Bid and the bidder with the next Lowest Calculated/Highest Rated Bid, and so on whichever is higher
c) in case of violations committed prior to the opening of the financial envelope	i) a fixed amount of two percent of the ABC,

3) I/We understand that this Bid Securing Declaration shall cease to be valid on the following circumstances:

- a) Upon expiration of the bid validity period, or any extension thereof pursuant to your request;
- b) I am/we are declared ineligible or post-disqualified upon receipt of your notice to such effect, and (i) I/we failed to timely file a request for reconsideration or (ii) I/we filed a waiver to avail of said right;
- c) I am/we are declared the bidder with the **Most Economically Advantageous Responsive Bid** and I/we have furnished the performance security and signed the Contract.

IN WITNESS WHEREOF, I/We have hereunto set my/our hand/s this ____ day of [month] [year] at [place of execution].

Duly authorized to sign the Bid for and behalf of:

[Insert Bidder's Name]

[Signature over Printed Name]

[Position/Designation]

[Date]

JURAT

SUBSCRIBED AND SWORN to before me this ____ day of *[month]* *[year]* at *[place of execution]*, Philippines. Affiant/s is/are personally known to me and was/were identified by me through competent evidence of identity as defined in the 2004 Rules on Notarial Practice (A.M. No. 02-8-13-SC). Affiant/s exhibited to me his/her *[insert type of government identification card used]*, with his/her photograph and signature appearing thereon, with no. _____.

WITNESS MY HAND AND SEAL this ____ day of *[month]* *[year]*.

NAME OF NOTARY PUBLIC

Notarial Commission No. _____

Notary Public for _____ until _____

Roll of Attorneys No. _____

PTR No. __, *[date issued]*, *[place issued]*

IBP No. __, *[date issued]*, *[place issued]*

Doc. No. _____

Page No. _____

Book No. _____

Series of _____

Section X. Other Related Forms Required by the Procuring Entity

TABLE OF CONTENTS

Waste Disposal Plan.....	96110
Local Hiring Plan.....	98
Innovation Proposal	1013
Detailed Methodology Statement.....	10514
Risk Management Plan.....	1015
Quality Assurance/Quality Control Plan	10516
Sworn Affidavit of Eligibility and Beneficial Ownership	10517
Summary of Bid Prices	10519
Summary of Program of Works Template	10520
Checklist of Bidding Documents	10521

WASTE DISPOSAL PLAN

PROJECT DETAILS

Project Name	CREATION OF TESDA-ISAT DIPLOMA CENTER
Project ID	TESDAR02-2026-001
Location	Calamagui 2nd, City of Ilagan, Isabela
Contractor / Bidder	

IDENTIFIED WASTES	PROPER HANDLING MEASURES	DISPOSAL MEASURES	SCHEDULE OF IMPLEMENTATION	Responsible Person

Nothing Follows

I, the undersigned, hereby commit that our firm will implement, follow and perform the procedures stated in this Detailed Methodology Statement as part of our contractual and social obligations under RA 12009.

(Signature over Printed Name)

Authorized Representative

Date signed: _____

LOCAL HIRING AND MANPOWER DEVELOPMENT PLAN

PROJECT DETAILS

Project Name	CREATION OF TESDA-ISAT DIPLOMA CENTER
Project ID	TESDAR02-2026-001
Location	Calamagui 2 nd , City of Ilagan, Isabela
Contractor / Bidder	

I. OBJECTIVES AND LEGAL BASIS

In accordance with the **Sustainable Public Procurement (SPP)** principles of **Republic Act No. 12009 (New Government Procurement Act)**, the Contractor hereby commits to prioritize the hiring of local labor. This plan ensures that the infrastructure project provides maximum socio-economic benefits to the host community through:

1. **Inclusive Procurement:** Integrating local residents into the project's labor supply chain.
2. **Skills Advancement:** Prioritizing **TESDA-Certified** workers to ensure quality and safety.
3. **Mandatory Thresholds:** Adhering to the social sustainability standards of at least **50% for unskilled** and **30% for skilled** local labor.

II. DETAILED MANPOWER COMMITMENT SCHEDULE

*The Contractor shall utilize the following targets, ensuring the **50/30 Rule** is strictly met.*

Specific Trade / Work Category	Total Manpower Required (A)	Target No. of Local Hires (B)	Local % (B/A)	Min. Certification Requirement
1. SKILLED LABOR (Min. 30%)				
• Foreman				Carpentry NC II
• Mason				Masonry NC II
• Carpenter				Carpentry NC II
• Scaffolder				Scaffolding Works NC II (Supported Type Scaffold)

• Back Hoe Operator				Heavy Equipment Operation – Backhoe Loader
• Dump Truck Driver				Heavy Equipment Operation (HEO) - Dump Truck NC II
• Plumber				Plumbing NC II
• Tile Setter				Tile Setting NC II
• Electrician				EIM NC II
• Welder				SMAW NC II
2. UNSKILLED LABOR (Min. 50%)				
• Helpers / Common Labor				Brgy. Clearance
GRAND TOTAL				

III. IMPLEMENTATION AND COMPLIANCE

- **The 50/30 Rule:** Under the sustainability mandate of RA 12009, the Contractor must ensure that at least **50% of the unskilled labor** and **30% of the skilled labor** requirements are sourced from the municipality or province where the project is located.
- **Priority Sourcing:** The Contractor shall prioritize graduates from **TESDA Region 02** training centers and the local **Registry of Workers Assessed and Certified (RWAC)**.
- **Verification:** The Contractor must submit a **Monthly Manpower Utilization Report** as a mandatory attachment to every progress billing to verify compliance with this plan.
- **Non-Availability:** If specific technical skills are unavailable locally, the Contractor shall issue a duly notarized **Certification of Non-Availability** before hiring non-residents.

IV. ATTESTATION

I, the undersigned, hereby commit that our firm will implement this Local Hiring Plan as part of our contractual and social obligations under **RA 12009**.

(Signature over Printed Name)

Authorized Officer / Representative

Date signed: _____

INNOVATION PROPOSAL

INNOVATION PROPOSAL				
PROJECT DETAILS				
Project Name	CREATION OF TESDA-ISAT DIPLOMA CENTER			
Project ID	TESDAR02-2026-001			
Location	Calamagui 2nd, City of Ilagan, Isabela			
Contractor / Bidder				
Area of Innovation	Detailed Narrative Specific Innovation Strategy	Expected Output	Timeline of Implementation	Responsible Person
Fast-Track Implementation				
Added Design Without Additional Cost to PE				
Cost Reduction Measures				
Others (Digitalization & Sustainability Initiative & Green Innovations)				
Nothing Follows				
I, the undersigned, hereby commit that our firm will implement the listed Innovation Proposal as part of our contractual and social obligations under RA 12009.				
(Signature over Printed Name) Authorized Representative				
Date signed:				

DETAILED METHODOLOGY STATEMENT

PROJECT DETAILS

Project Name	CREATION OF TESDA-ISAT DIPLOMA CENTER
Project ID	TESDAR02-2026-001
Location	Calamaqui 2nd, City of Ilagan, Isabela
Contractor / Bidder	

ITEM/WORKS	Detailed Narrative Description/Activity to be Performed	Timeline of Implementation	Responsible Person
I. Preliminaries			
II. Earthworks			
III. Concrete Works			
IV. Rebar Works			
V. Formworks and Scaffoldings			
VI. Masonry Works/Partition Wall			
VII. Roofing Works			
VIII. Electrical Works			
IX. Plumbing Works			
X. Tile Works/Floor and Wall Finishes			
XI. Ceiling Works			
XII. Painting Works			
XIII. Doors and Windows			
XIV. Miscellaneous			
Nothing Follows			

I, the undersigned, hereby commit that our firm will implement, follow and perform the procedures stated in this Detailed Methodology Statement as part of our contractual and social obligations under RA 12009.

(Signature over Printed Name)
Authorized Representative

Date signed:

RISK MANAGEMENT PLAN

RISK MANAGEMENT PLAN			
PROJECT DETAILS			
Project Name	CREATION OF TESDA-ISAT DIPLOMA CENTER		
Project ID	TESDAR02-2026-001		
Location	Calamagui 2nd, City of Ilagan, Isabela		
Contractor / Bidder			
IDENTIFIED RISK/S	PREVENTIVE/CORRECTIVE/CORRECTION ACTIONS	Days to Implement Preventive/ Corrective/ Correction Action	Responsible Person
Nothing Follows			
<p>I, the undersigned, hereby commit that our firm will implement, follow and perform the procedures stated in this Detailed Methodology Statement as part of our contractual and social obligations under RA 12009.</p>			
(Signature over Printed Name) Authorized Representative			
Date signed:			

QUALITY ASSURANCE/QUALITY CONTROL PLAN

QUALITY ASSURANCE/QUALITY CONTROL PLAN				
PROJECT DETAILS				
Project Name	CREATION OF TESDA-ISAT DIPLOMA CENTER			
Project ID	TESDAR02-2026-001			
Location	Calamagui 2nd, City of Ilagan, Isabela			
Contractor / Bidder				
QUALITY CONTROL ISSUES/PROBLEMS	QUALITY CONTROL MEASURES	EXPECTED OUTPUT	Days to Implement Quality Measures	Responsible Person
Nothing Follows				
I, the undersigned, hereby commit that our firm will implement, follow and perform the procedures stated in this Detailed Methodology Statement as part of our contractual and social obligations under RA 12009.				
(Signature over Printed Name)				
Authorized Representative				
Date signed:				

SWORN AFFIDAVIT OF ELIGIBILITY AND BENEFICIAL OWNERSHIP

I, [Name of Authorized Representative], of legal age, [nationality], with office address at [Company Address], after having been duly sworn in accordance with law, hereby depose and state that:

1. That I am the [position/title] and duly authorized representative of [Name of Corporation/Contractor], a corporation duly organized and existing under the laws of the Republic of the Philippines, registered with the Securities and Exchange Commission (SEC) under Company Registration No. [insert SEC registration number];
2. That the Corporation is duly registered with the Philippine Government Electronic Procurement System (PhilGEPS) and is participating in the procurement activities of the Technical Education and Skills Development Authority-Region II (TESDA-Region II),
3. That in compliance with Section 20.2.9.1 and Section 82 of the Implementing Rules and Regulations (IRR) of Republic Act No. 12009, otherwise known as the New Government Procurement Act (NGPA), and PhilGEPS Advisory No. 2025-007, the Corporation has submitted its latest General Information Sheet (GIS), duly received by the Securities and Exchange Commission (SEC), reflecting its Beneficial Ownership Information (BOI), and has maintained the same valid and updated in the Philippine Government Electronic Procurement System (PhilGEPS). That the following are the beneficial owner/s of the Corporation, as reflected in its latest SEC-filed GIS:

COMPLETE NAME (Surname, Given Name, Middle Name, Extension)	SPECIFIC RESIDENTIAL ADDRESS	NATIONALITY	DATE OF BIRTH	TAX IDENTIFICATION NO.	% OF OWNERSHIP / % OF VOTING RIGHTS	TYPE OF BENEFICIAL OWNER (Direct/Indirect)

4. That the above beneficial ownership information is true and correct based on the Corporation's official and most recent records submitted to the SEC;
5. That the Corporation is eligible to participate in government procurement under R.A. No. 12009, and none of its directors, officers, or beneficial owners are disqualified under existing laws, rules, and regulations;
6. That I undertake to immediately inform the TESDA-Region II, and submit an updated GIS and affidavit should there be any changes in the Corporation's beneficial ownership or control structure; and
7. That this affidavit is executed to attest to the truth of the foregoing statements and in compliance with the submission requirements for the bidding documents of the TESDA-Region II, pursuant to the provisions of Republic Act No. 12009, its Implementing Rules and Regulations (IRR), and relevant GPPB issuances.

IN WITNESS WHEREOF, I have hereunto set my hand this _____ day of _____,
20____, at _____.

[Signature over Printed Name]
[Name of Authorized Representative]
[Position / Title]
For and on behalf of
[Name of Corporation / Contractor]

SUBSCRIBED AND SWORN to before me this _____ day of _____, 20____, at
_____, affiant exhibiting to me his/her [Government-issued ID Type and
No.] issued on _____ at _____.

Doc. No. ; _____
Page No. ; _____
Book No. ; _____
Series of 20 _____.



ISABELA SCHOOL OF ARTS AND TRADES
Calamagui 2nd, City of Ilagan, Isabela

Project ID : TESDAR02-2026-001
 Project : Creation of Isabela School of Arts and Trades (ISAT) Diploma Center
 Location : Calamagui 2nd, City of Ilagan, Isabela
 Project Description : Completion for Construction of 3-Storey PQF Level 5 (Diploma) Building

ITEM NO.	DESCRIPTION OF WORKS TO BE DONE	AMOUNT
Item I	Preliminaries	
Item II	Earthworks	
Item III	Concrete Works	
Item IV	Rebar Works	
Item V	Formworks and Scaffoldings	
Item VI	Masonry Works/Partition Wall	
Item VII	Roofing Works	
Item VIII	Electrical Works	
Item IX	Plumbing Works	
Item X	Tile Works/Floor and Wall Finishes	
Item XI	Ceiling Works	
Item XII	Painting Works	
Item XIII	Doors and Windows	
Item XIV	Miscellaneous	
	TOTAL AMOUNT	-

Total Amount in Words

Name _____ in the capacity of _____

Signed _____ Date _____

Duly Authorized to sign the bid for and on behalf of _____

CHECKLIST OF BIDDING DOCUMENTS

I.1. TECHNICAL COMPONENT ENVELOPE (GENERAL CONTRACTOR)	
<i>Class "A" Documents</i>	
<u>Legal Documents</u>	
(a)	PhilGEPS Certificate of Registration (Platinum Membership) in accordance with Section 20 of the IRR (all pages); <u>and</u>
<u>Technical Documents</u>	
(b)	Statement of the prospective bidder of all its ongoing government and private contracts, including contracts awarded but not yet started, if any, whether similar or not similar in nature and complexity to the contract to be bid; <u>and</u>
(c)	Statement of the Bidder's SLCC, in accordance with ITB Clause 5.5. The SLCC shall be supported by an Owner's Certificate of Final Acceptance issued by the project owner other than the Contractor, or a final rating of at least satisfactory in the CPES, or a similar performance and monitoring system. In case of contracts with the private sector, an equivalent document shall be submitted; <u>and</u>
(d)	PCAB License; <u>or</u> Special PCAB License in case of Join Ventures; <u>and</u> registration for the type and cost of the contract to be bid; <u>and</u>
(e)	Bid Security in the prescribed form and amount in accordance with ITB Clause 16, and validity period under ITB Clause 15; <u>and</u>
(f)	Project Requirements, which shall include the following:
	(f.1) Organizational chart for the contract to be bid; and
	(f.2) List of contractor's key personnel (e.g., Project Manager, Project Engineers, Materials Engineers, and Foreman), to be assigned to the contract to be bid, with their complete qualification and experience data; and
	(f.3) List of contractor's major equipment units, which are owned, leased, and/or under purchase agreements, supported by proof of ownership or certification of availability of equipment from the equipment lessor/vendor for the duration of the project, as the case may be; and
	(f.4) Additional Project Requirements (Documents for MEAB Evaluation), which shall include the following:
	List of Completed Similar Project/s
	Certificates of Completion of Listed Completed Similar Project/s
	Contracts of Listed Completed Similar Project/s
	CPES Ratings or Performance Evaluation Certificate of Listed Completed Similar Project/s
	Curriculum Vitae of Key Personnel
	PRC Licenses of Key Personnel, if applicable
	Employment Certificates of Key Personnel
	Affidavit of Availability of Key Personnel
	Waste Disposal Plan
	Local Hiring Plan in Compliance to RA 6685 (Of the Total Skilled 30%-Skilled within the locality; Of the Total Unskilled 50%-Unskilled within the locality)
	National Certificate Requirement (use template in the Section IX. Philippine Bidding Documents Related Forms Annex A List of Skilled/Unskilled Workers Assigned for the Project)
	Certified True Copies of National Certificate

	Manpower Schedule
	Innovation Proposal
	Detailed Methodology Statement (Construction Methods)
	PERT/CPM
	Construction Schedule and S-curve
	DOLE Approved Construction Safety and Health Program or DOLE Stamped Received Construction Safety and Health Program
	Risk Management Plan
	QA/QC Plan
	Proof of Ownership (OR/CR) or Lease Agreements of the Listed Equipment
	Pictures of the Listed Equipment
	Equipment Utilization Schedule
	Equipment Specifications of the Listed Equipment
	Statement of Ongoing Contracts, if No Ongoing Contracts, submit the required template and indicate "No Ongoing Contracts"
	NOA of Ongoing Contracts, if with Ongoing Contracts
	Contacts of Ongoing Contracts, if with Ongoing Contracts
	NTP of Ongoing Contracts
	For Contract Implementation with delays attach Approved Contract Time Extension
	BIR Stamped Received Latest Audited Financial Statements
	NFCC Computation
(g)	Original duly signed Omnibus Sworn Statement (OSS) in accordance with Section 54.3 of the IRR; and
(h)	Sworn Affidavit of Eligibility and Beneficial Ownership
<u>Financial Documents</u>	
(i)	NFCC computation in accordance with ITB Clause 5.6
<u>Class "B" Documents</u>	
(j)	Joint Venture Agreement (JVA), if applicable.
I.2. TECHNICAL COMPONENT ENVELOPE (SUBCONTRACTOR)	
i)	PhilGEPS Certificate of Registration (Platinum Membership);
ii)	Statement of SLCC;
iii)	NFCC Computation or committed Line of Credit (LoC);
iv)	Statement of all its ongoing government and private contracts, including contracts awarded but not yet started, if any, whether similar or not similar in nature and complexity to the contract to be bid;
v)	[if applicable] JVA) or in the absence of a JVA, duly notarized statements from all potential JV partners stating that they will enter into and abide by the provisions of the JVA in the event that the bid is successful;
vi)	Bid Security in the prescribed form and amount in accordance with ITB Clause 16, and validity period under ITB Clause 15;
vii)	Technical Specifications, which may include production or delivery schedule, manpower requirements, or after-sales service or parts, if applicable;
viii)	Omnibus Sworn Statement; and
ix)	For foreign Bidders claiming eligibility by reason of their country's extension of reciprocal rights to Filipinos, a certification from the relevant government office of their country stating that Filipinos are allowed to participate in their government procurement activities for the same item or product.

II. FINANCIAL COMPONENT ENVELOPE	
(a)	Original of duly signed and accomplished Financial Bid Form; <u>and</u>
(b)	Original of duly signed Bid Prices in the Bill of Quantities; <u>and</u>
(c)	Detailed Estimates Form, including summary sheet indicating unit prices of construction materials, labor rates, and equipment rentals used in coming up with the bid; <u>and</u>
(d)	Cash Flows by Quarter; <u>and</u>
(e)	Summary of Program of Works; <u>and</u>
(f)	Summary of Bid Prices

